

160 *Super Sport*

Owner's Manual



THE UNSINKABLE LEGEND

160 Super Sport

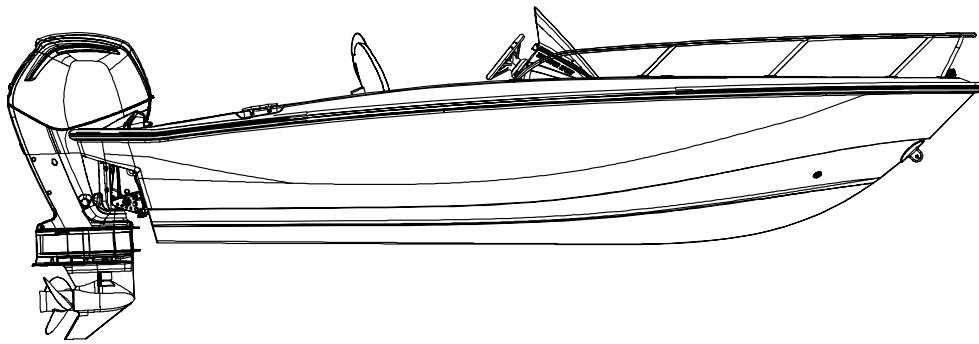

“The mission of Boston Whaler® is to provide consumers with the safest, highest quality, most durable boats in the world.”

 **WARNING**

Operating, servicing and maintaining a recreational marine vessel can expose you to chemicals including engine exhaust, carbon monoxide, phthalates, and lead, which are known to the State of California to cause cancer and birth defects or other reproductive harm. To minimize exposure, avoid breathing exhaust, service your vessel in a well-ventilated area and wear gloves or wash your hands frequently when servicing this vessel. For more information go to www.P65warnings.ca.gov/marine.

Welcome to the Boston Whaler family! Congratulations on your purchase of a Boston Whaler boat.

For over six decades, Boston Whaler has been represented by a select group of the best dealers in the boating industry. Boston Whaler depends on this extremely qualified network of dealers to provide you, our customer, with a truly exceptional boating experience.

Should you have any questions or concerns regarding your boat, please don't hesitate to contact your selling dealer. They will be more than happy to provide you with all the information and assistance that you require.

Information and assistance is also available at our corporate website, www.bostonwhaler.com. On our website you will find information on our entire lineup of Unsinkable Legends, as well as a collection of customer resources including parts diagrams, maintenance tips and frequently asked questions. In addition, you can sign up to receive future issues of Boston Whaler's lifestyle magazine, *Whaler*.

Since Boston Whaler's inception in 1958, we have been committed to providing customers with the safest, highest quality, most durable boats in the world. I am confident that you, as a Whaler owner, will also appreciate the quality and pride that is built into every Boston Whaler boat.

From all of us here at Whaler, thank you for purchasing one of our boats. May it bring you many years of boating enjoyment.

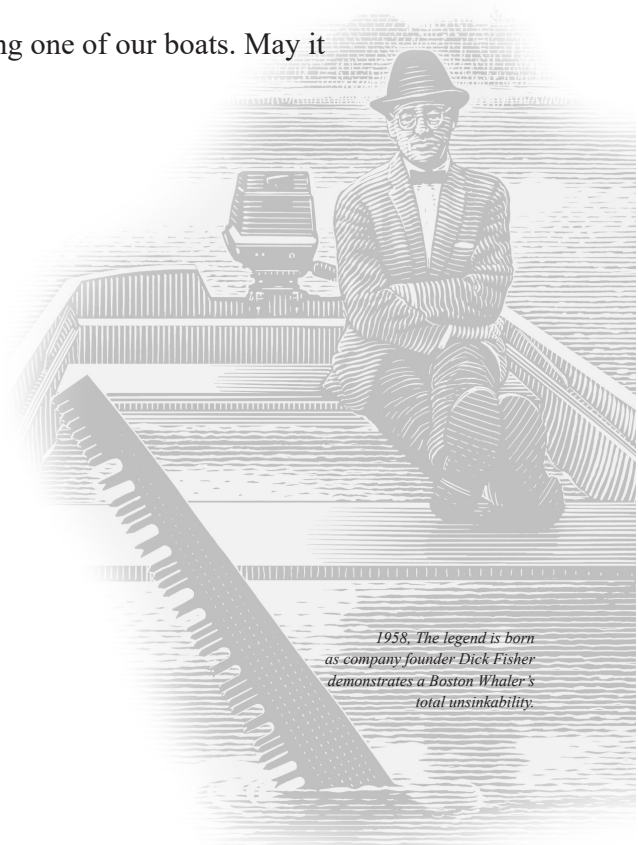

1958. The legend is born as company founder Dick Fisher demonstrates a Boston Whaler's total unsinkability.

HISTORY

In 1958, company founder Richard T. Fisher introduced the first Boston Whaler® boat in Braintree, Massachusetts. It featured two significant innovations: first, its twin sponson hull design produced superior stability and a remarkably dry ride; second, its unique foam core construction made the boat not only durable, but unsinkable as well.

Fisher took every opportunity to illustrate the unique characteristics of the Boston Whaler®. His most famous demonstration was captured in 1961, by *Life Magazine*. The series of photographs showed the boat underway, the boat being sawed in half and ultimately Fisher motoring away in the remaining half of the boat. And through the years many other demonstrations have proved the toughness and durability of the Boston Whaler hull. And though you may never cut your boat in half, this only goes to show one thing, people whose livelihood and lives depend on boats consistently choose Boston Whaler® because of their seaworthiness, dependability and the inherent safety of a hull that won't sink even if severely damaged.

Boston Whalers are built to last. For over 50 years Boston Whaler® has strived to make each model better, providing you with a safe and fun boating experience. That is the reason we offer a 10 year limited transferable warranty. It is also an excellent reason why you can trust the safety of your family and friends to a Boston Whaler®.

On September 26, 1996, Richard T. Fisher was posthumously inducted into the NMMA (National Marine Manufacturer's Association) Hall of Fame for accomplishments made in marine engineering and construction.

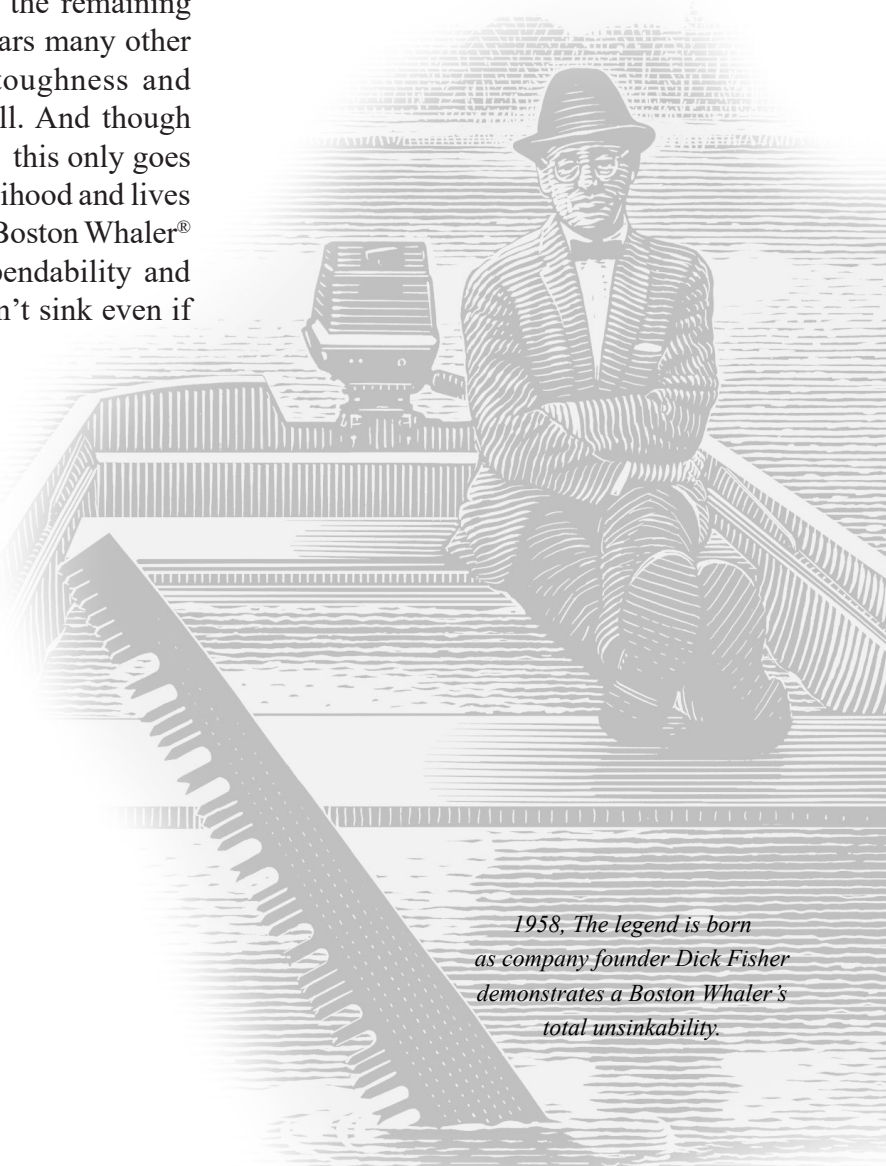

*1958, The legend is born
as company founder Dick Fisher
demonstrates a Boston Whaler's
total unsinkability.*

**PLEASE KEEP THIS OWNER'S MANUAL PACKET IN A SECURE PLACE, AND BE SURE
TO HAND IT OVER TO THE NEW OWNER IF YOU SELL THE BOAT.**

TABLE of CONTENTS

| | |
|---|---|
| <p>Welcome Letter iii</p> <p>History iv</p> <p>Preface vii</p> <p>Boston Whaler Limited Manufacturer Warranty (US and Canada) viii</p> <p>Boston Whaler Limited Manufacturer Warranty (Non US or Canada) xiii</p> <p>California Evaporative Emissions Control System Warranty Statement xvii</p> <p>Privacy Statement xviii</p> <p>Introduction xix</p> <p style="padding-left: 20px;">Owner’s manual xix</p> <p style="padding-left: 20px;">Your responsibilities xix</p> <p>Source of Information xix</p> <p style="padding-left: 20px;">Warranties xix</p> <p>Contact Phone Numbers and Internet Addresses xix</p> <p>Section 1 • Safety</p> <p>Explanation of Safety Precautions 1-1</p> <p>Warning Labels 1-1</p> <p>Safety Precautions 1-1</p> <p>Safe Boating means 1-2</p> <p style="padding-left: 20px;">In Addition 1-2</p> <p>Safe Boating Checklist 1-2</p> <p style="padding-left: 20px;">Before departure 1-2</p> <p style="padding-left: 20px;">Trailing (if applicable) 1-2</p> <p style="padding-left: 20px;">After Return 1-2</p> <p>General Considerations 1-3</p> <p>Maintain Control 1-3</p> <p>Boarding 1-3</p> <p>Impaired Operation 1-3</p> <p>Legally Mandated Equipment (Minimum Required) 1-5</p> <p style="padding-left: 20px;">Personal Flotation devices (PFD’s) 1-5</p> <p style="padding-left: 20px;">Fire Extinguisher (Portable) 1-5</p> <p style="padding-left: 20px;">Whistle, Horn 1-5</p> <p style="padding-left: 20px;">Visual Distress Signal 1-5</p> <p>Additional recommended Equipment for Safe Operation 1-5</p> <p>Carbon Monoxide (CO) 1-6</p> <p>Lifesaving Equipment 1-7</p> <p style="padding-left: 20px;">PFD Requirement 1-7</p> <p style="padding-left: 20px;">PFD Classification 1-7</p> <p>Emergency Situations 1-9</p> <p style="padding-left: 20px;">Medical Emergency 1-9</p> <p style="padding-left: 20px;">Water Rescue 1-9</p> | <p>Returning to the victim 1-9</p> <p>Making contact 1-9</p> <p>Getting back aboard 1-9</p> <p>Unassisted Reboarding 1-9</p> <p>Fire 1-9</p> <p>Flooding, Swamping and Capsizing 1-10</p> <p style="padding-left: 20px;">Flooding 1-10</p> <p style="padding-left: 20px;">Swamping 1-10</p> <p style="padding-left: 20px;">Capsizing 1-10</p> <p>Collision 1-11</p> <p>Propulsion, Control or Steering Failure 1-11</p> <p>Grounding 1-11</p> <p>Distress Signals 1-11</p> <p style="padding-left: 20px;">Visual distress signals (VDS) 1-11</p> <p style="padding-left: 20px;">Audible distress signals 1-12</p> <p>Radio Communication 1-12</p> <p>Weather 1-12</p> <p>Swimming, Diving & Water Skiing 1-13</p> <p style="padding-left: 20px;">Swimming 1-13</p> <p style="padding-left: 20px;">Diving 1-13</p> <p style="padding-left: 20px;">Water Skiing 1-14</p> <p style="padding-left: 20px;">Water Skiing Signals 1-14</p> <p>Emergency Engine Stop Switch 1-16</p> <p>Float Plan 1-16</p> <p>Chart Your Course 1-16</p> <p>Environmental Considerations 1-17</p> <p style="padding-left: 20px;">Fuel & Oil Spillage 1-17</p> <p>Excessive Noise 1-17</p> <p>Wake/Wash 1-17</p> <p>Homeland Security Restrictions 1-18</p> <p>America’s Waterway watch 1-18</p> <p>Warning Label Locations 1-18</p> <p>Key To Symbols Used on Controls & Prints 1-21</p> <p>Section 2 • General Information</p> <p>Construction Standards 2-1</p> <p>Our Hull 2-1</p> <p style="padding-left: 20px;">Hull Identification Number 2-1</p> <p>Servicing Your Boston Whaler 2-1</p> <p>Manufacturer’s Certification 2-1</p> <p style="padding-left: 20px;">Certification design Category 2-3</p> |
|---|---|

| | |
|---------------------------------------|------|
| Power Capacity..... | 2-3 |
| Specifications & Dimensions..... | 2-4 |
| Passenger Areas..... | 2-5 |
| Recommended Passenger Locations | 2-6 |
| Location Of Thru-Hull Fittings..... | 2-7 |
| Features | 2-8 |
| Optional Features | 2-9 |
| Gear Shift & Throttle Control..... | 2-10 |
| Power Trim Operation | 2-10 |
| Navigation Lighting..... | 2-11 |
| Steering | 2-12 |
| Steering Pull | 2-12 |
| Trim Tab Adjustment..... | 2-12 |
| Propeller..... | 2-13 |
| Lifting, Towing, and Trailering | 2-13 |
| Bow tow Eye (Option)..... | 2-14 |
| Out of Water Lifting | 2-14 |
| Trailer safety..... | 2-15 |
| Securing Boat to Trailer..... | 2-15 |
| Securing Trailer to Tow Vehicle | 2-15 |
| Trailer Hitch | 2-15 |
| Outboard Engine..... | 2-16 |

Section 3 • Systems & Components Overview & Operation

| | |
|--|-----|
| Fuel System..... | 3-1 |
| Primer Bulb..... | 3-1 |
| Oil Usage..... | 3-2 |
| Fuel & Oil Spillage | 3-2 |
| Static Electricity and the Fuel System.... | 3-2 |
| Ethanol-Blended Fuel..... | 3-3 |
| Filling The Tank | 3-3 |
| Phase Separation..... | 3-3 |
| Additives..... | 3-4 |
| Fuel Filters | 3-4 |
| Fuel/Water Separator (Option)..... | 3-4 |
| Maintenance..... | 3-4 |
| Fuel Systems w/Portable Tanks..... | 3-4 |
| Storage..... | 3-4 |
| Starting the Engine..... | 3-5 |
| Prior to Starting..... | 3-5 |
| Start Engine | 3-6 |
| Warming Up the Engine..... | 3-6 |
| Stopping the Engine | 3-6 |
| VesselView (Option) | 3-6 |
| Bow Cushion (Option)..... | 3-7 |

| | |
|---|------|
| Installing The Bow Cushion..... | 3-7 |
| Bench Seat Cushions (Option)..... | 3-7 |
| Sport Bench Seat (Option) | 3-7 |
| Console Side Cooler (Option) | 3-7 |
| Console Side Cooler Cushion (Option)..... | 3-8 |
| Installing The Side Cooler Cushion..... | 3-8 |
| Sun Top (Option)..... | 3-8 |
| To Raise the Sun Top | 3-8 |
| Rail Mounted Rodholder (Option)..... | 3-8 |
| Swim Ladder..... | 3-9 |
| Ski Tow (Option) | 3-9 |
| Anchoring | 3-9 |
| Bow light w/Rope Guide..... | 3-9 |
| Considerations..... | 3-9 |
| Lowering the Anchor..... | 3-10 |
| Setting the Anchor..... | 3-10 |
| Weighing the Anchor | 3-10 |

Section 4 • Electrical

| | |
|---------------------------------|-----|
| Electrical System | 4-1 |
| DC Electrical System | 4-1 |
| Battery | 4-1 |
| Battery Box..... | 4-1 |
| Battery Switch (CE Option)..... | 4-2 |
| 12V Accessory Receptacle..... | 4-2 |
| Navigation Lighting..... | 4-2 |
| Electrical Schematics | 4-3 |

Section 5 • Care & Maintenance

| | |
|---|-----|
| Routine Care & Maintenance | 5-1 |
| Hull | 5-1 |
| Waxing the Gel Coat Surfaces | 5-1 |
| Hull Maintenance..... | 5-2 |
| Hull Blistering | 5-2 |
| Prevention | 5-2 |
| Bottom Painting | 5-2 |
| Bottom Painting a Bare Hull..... | 5-3 |
| Bottom Painting a Pre-Painted Hull..... | 5-3 |
| Rubrail care | 5-4 |
| Cleaning Fiberglass & Non-Skid | 5-4 |
| Stainless Steel Care..... | 5-4 |
| Aluminum Care | 5-5 |
| Cushions..... | 5-5 |

| | |
|---|------|
| Cleaning Instrument Gauges | 5-6 |
| Canvas Care and Maintenance..... | 5-6 |
| Maintaining Zippers and Hardware..... | 5-7 |
| Hull Wrap Care..... | 5-7 |
| Powder Coating Touch-Up..... | 5-7 |
| Long term Storage & Winterization | 5-8 |
| Engine..... | 5-8 |
| Fuel System | 5-9 |
| Electrical System | 5-9 |
| Battery | 5-9 |
| Deck..... | 5-9 |
| Drainage..... | 5-9 |
| Avoid Loss | 5-9 |
| Cover | 5-9 |
| Trailer Storage | 5-10 |
| Environment | 5-10 |
| Reinforcement Locations..... | 5-10 |

Preface

READ AND RETAIN this manual. If the boat is sold, ensure all documentation is transferred to the new owner.

Information in this publication is based on the latest product specifications available at the time of printing. Boston Whaler reserves the right to make changes at any time without prior notice. Boston Whaler is not responsible for specification changes to parts or accessories manufactured by other companies.

NOTE: Equipment may vary depending on options selected.

If needed in connection with selling your boat, service history or warranty records on vessels should be requested from the original selling dealer, the servicing dealer and/or the previous owner (where applicable). Information regarding open safety recalls is maintained by the United States Coast Guard, and can be obtained by visiting uscgboating.org.

Brunswick Corporation registered trademarks: Mercury Marine, Mercury Racing, Optimax, Nautic-On, Skyhook, SmartCraft, Verado, Vantage, VesselView, VesselView Mobile, Fathom.

Boston Whaler, Inc. registered trademarks: Boston Whaler, Boston Whaler with harpoon and hull logo, Conquest, Dauntless, Montauk, Outrage, Realm, Unibond, Whaler.

All other trademarks listed in this publication are the property of their respective owners.

BOSTON WHALER® • A BRUNSWICK COMPANY

© June 2020 Brunswick Corporation



BOSTON WHALER LIMITED MANUFACTURER WARRANTY (US AND CANADA)

Boston Whaler, Inc. (“Boston Whaler”) provides the following Limited Manufacturer Warranty to the original retail owner of its 2025 model year Boats, if purchased from an authorized Boston Whaler Dealer and operated under normal, non-commercial use, subject to the remedies, exclusions, and limitations set out below.

1. **Ten-Year Structural Hull Limited Warranty:** Any Structural Hull Defect in material or workmanship which is reported within ten (10) years from the date of sale to the original retail owner will be repaired or replaced at Boston Whaler’s sole discretion. The “Hull” shall mean the single fiberglass molded shell and integral structural components. A Structural Hull Defect shall mean a substantial defect in the Boat’s Hull which causes the Boat to be unfit or unsafe for general use as a pleasure craft under normal operating conditions.
2. **Three-Year Limited Warranty on Components Manufactured or Installed By Boston Whaler: (not applicable to 13 Super Sport or 16 Super Sport models):** Boston Whaler will repair or replace, at its sole discretion, any components manufactured or installed by Boston Whaler that are defective in factory materials and/or workmanship, which are reported within three (3) years from the date of delivery to the first retail purchaser, and are not addressed in the specific warranties listed in paragraphs 1 or 4 or set out in the Exclusions paragraph below.
3. **One-Year Limited Warranty on Accessory Components for the 13 Super Sport and 16 Super Sport Models:** Boston Whaler provides the following Limited Warranty to the original retail owner of any factory-authorized accessory for the 2025 model year 13 Super Sport and 16 Super Sport, if purchased from an authorized Boston Whaler Dealer, authorized Boston Whaler website or any Boston Whaler affiliate and utilized under normal, non-commercial use (“Accessory”), subject to the remedies, exclusions, and limitations set out below. Boston Whaler will repair or replace, at its sole discretion, any Accessory that is defective in material or workmanship, which is reported within one (1) year from the date of delivery to the first retail purchaser. Boston Whaler is not responsible for any defect and/or damage to the Accessory and/or the Boat caused by improper installation, whether performed by the retail owner, dealer or any other third party.
4. **One-Year Limited Warranty on Upholstered Items, Canvas, Teak, and Powder Coating:** Boston Whaler will repair or replace, at its sole discretion, any upholstered items, canvas, teak, and powder coating manufactured or installed by Boston Whaler that are defective in factory materials and/or workmanship and are reported within one (1) year from the date of delivery to the first retail purchaser.
5. **Limited Engine Warranty:** Retail owners will be entitled to the limited engine warranty as provided in the warranty manual from the engine manufacturer that was delivered to the retail owner with his or her Boston Whaler Boat.

EXCLUSIONS

This Limited Manufacturer Warranty does not apply to any Boat which has been salvaged or declared a total loss or constructive total loss for any reason not covered in this limited warranty. This Warranty also does not apply to the following items:

- 1) Expenses for hauling out or transportation to and from the dealer or Boston Whaler factory for warranty service.
- 2) Equipment or accessories which are not installed by Boston Whaler or which carry their own individual warranties, including but not limited to engines, engine components, batteries, propellers, controls, steering mechanisms, and electronics.
- 3) Damage, deterioration, discoloration or mold of cushions or cosmetic surface finishes, including scratches,

gouges, chips, chalking, blistering, cracking, crazing, fading or oxidation of gel coat, stress lines, plated or painted metal and stainless steel finishes, plastics or acrylic materials, or anti-fouling bottom paint.

4) Windshield breakage and leakage.

5) Any Boat initially sold at retail by a party other than an authorized Boston Whaler dealer.

6) Damage resulting from abuse, misuse, improper rigging and installation by an owner or any other person or entity that is not an authorized dealer, accidents, or overloading or powering in excess of the recommended maximum horsepower.

7) Failure of the owner to use, maintain, or store the Boat as specified in the Boston Whaler owner's manual; and any other failure to provide reasonable care and maintenance. Normal wear and tear maintenance items are excluded from warranty coverage including but not limited to filters, bulbs, batteries, bungees, wiper blades, anchor rope, trailer finishes, tires, brakes, bearings, and lights.

8) Any Boston Whaler Boat which has been altered or modified from Boston Whaler factory specifications, including penetration of the hull by anyone other than Boston Whaler factory personnel or Boston Whaler authorized dealer service personnel following factory specified procedures.

9) Damages resulting from use of improper trailer, improperly placed supporting bunks or slings, incorrect bunks placement, or improper boat lift or sling.

10) Damages due to failure to properly tow the Boat. For those Boats for which Boston Whaler offers a yacht tender package, damages due to towing when the package has not been installed.

11) Any Boston Whaler Boat used for commercial purposes, which includes, but is not limited to, any for-profit or other revenue-generating uses.

12) Any representation or implication relating to speed, range, fuel consumption or estimated performance characteristics.

13) Any failure or defect caused by an act of nature resulting in damage, cost, or expense.

14) Any failure or defect arising from a previous repair made by a non-authorized service provider.

15) Any item exceeding the expressed coverage limits specified in any Boston Whaler Limited Manufacturer Warranty.

16) Failure of the owner to use, maintain, or store an Accessory in reasonable fashion; and any other failure to provide reasonable care and maintenance.

17) Any accessory which has been altered or modified from Boston Whaler factory specifications.

18) Any accessory not purchased from an authorized Boston Whaler Dealer, authorized Boston Whaler website, or authorized Boston Whaler affiliate. For a list of Boston Whaler's affiliates, please refer to www.brunswick.com.

19) Any accessory used for commercial purposes, which includes but is not limited to, any for-profit or other revenue generating uses.

20) Any defect or repair requiring redesign of the Boat, except pursuant to the recall provisions of the United States Federal Boat Safety Act of 1971 or the recall laws of any other foreign jurisdiction.

SOLE REMEDY

THE REMEDY OF REPAIR OR REPLACEMENT OF PARTS OR MATERIALS THAT ARE FOUND TO BE DEFECTIVE IN FACTORY MATERIALS OR WORKMANSHIP COVERED BY THIS LIMITED MANUFACTURER WARRANTY SHALL CONSTITUTE THE OWNER'S SOLE AND EXCLUSIVE REMEDY AGAINST BOSTON WHALER FOR ANY CLAIMS WHATSOEVER OF ECONOMIC LOSS RESULTING FROM PRODUCT FAILURE.

ENVIRONMENTAL POLICIES

In keeping with environmental policies and practices, Boston Whaler reserves the right to utilize reconditioned, refurbished, repaired or remanufactured products or parts in the warranty repair or replacement process. Such products and parts will be comparable in function and performance to an original product or part and warranted for the remainder of the original warranty period. In no event shall any repair or replacement under this Limited Manufacturer Warranty exceed the fair market value of the product as of the date of the owner's claim. Acceptance of any product returned or any refund provided by Boston Whaler shall not be deemed an admission that the product is defective. Products that are replaced become the property of Boston Whaler.

OTHER LIMITATIONS

EXCEPT AS SET FORTH HEREIN, THERE ARE NO OTHER WARRANTIES, EITHER EXPRESS OR IMPLIED, PROVIDED BY BOSTON WHALER ON THIS BOAT. ALL OTHER WARRANTIES, EXPRESS OR IMPLIED, INCLUDING IMPLIED WARRANTIES OF FITNESS AND MERCHANTABILITY, ARE EXPRESSLY EXCLUDED. BOSTON WHALER FURTHER DISCLAIMS ANY LIABILITY FOR ECONOMIC LOSS ARISING FROM CLAIMS OF PRODUCT FAILURE, NEGLIGENCE, DEFECTIVE DESIGN, MANUFACTURING DEFECT, FAILURE TO WARN AND/OR INSTRUCT, LACK OF SEAWORTHINESS, AND ANY OTHER THEORY OF LIABILITY NOT EXPRESSLY COVERED UNDER THE TERMS OF THIS LIMITED MANUFACTURER WARRANTY.

ANY IMPLIED WARRANTY OF MERCHANTABILITY OR FITNESS FOR A PARTICULAR PURPOSE IS DISCLAIMED. TO THE EXTENT THE IMPLIED WARRANTY CANNOT BE DISCLAIMED, IT IS LIMITED TO THE SHORTER OF ONE YEAR FROM THE DATE OF DELIVERY TO THE FIRST RETAIL OWNER OR THE DURATION OF THE RESPECTIVE EXPRESS LIMITED WARRANTIES STATED HEREIN. TO THE EXTENT ALLOWED BY LAW, NEITHER BOSTON WHALER, NOR THE SELLING DEALER, SHALL HAVE ANY RESPONSIBILITY FOR LOSS OF THE BOAT, LOSS OF TIME, INCONVENIENCE, COMMERCIAL LOSS OR CONSEQUENTIAL DAMAGES. SOME STATES DO NOT ALLOW LIMITATIONS ON HOW LONG AN IMPLIED WARRANTY LASTS, SO THE ABOVE LIMITATION MAY NOT BE APPLICABLE. SOME STATES DO NOT ALLOW THE EXCLUSION OR LIMITATION OF INCIDENTAL OR CONSEQUENTIAL DAMAGES, SO THE ABOVE LIMITATIONS OR EXCLUSIONS MAY NOT BE APPLICABLE. THIS WARRANTY GIVES THE OWNER SPECIFIC LEGAL RIGHTS, AND THE OWNER MAY ALSO HAVE OTHER RIGHTS WHICH VARY FROM STATE TO STATE OR COUNTRY TO COUNTRY.

STATUTE OF LIMITATIONS

Any action for rescission or revocation against Boston Whaler shall be barred unless it is commenced within one (1) year from the date of accrual of such cause of action. This provision does not grant any consumer a right of rescission or revocation against Boston Whaler, where such right does not otherwise exist under applicable law. Some states may not allow the applicable statute of limitations for rescission or revocation to be reduced, so this provision may not apply to each retail owner.

OWNER'S OBLIGATIONS

To initiate a warranty claim, it is the responsibility of the owner to contact an authorized Boston Whaler dealer immediately after discovery of any defect, describe the nature of the problem, and provide a hull serial number, date of purchase, and name of selling dealer. The authorized dealer will notify Boston Whaler, who is solely responsible for determining and authorizing in writing the remedial action(s) to be performed at either an authorized Boston Whaler dealership chosen by Boston Whaler or at the Boston Whaler factory.

The owner should notify Boston Whaler of any Boat being repaired by an authorized Boston Whaler dealer which has been at the dealership for fifteen (15) days, or of any claimed defect which was not corrected after one repair attempt. The owner must provide Boston Whaler with a reasonable opportunity to repair, and reasonable access to the Boston Whaler Boat for warranty service and the owner shall pay for all related transportation charges and/or travel time. If the owner cannot deliver the product to such a dealer, written notice must be given to Boston Whaler. Boston Whaler will then arrange for the inspection and any covered repair and the owner shall pay for all related transportation charges and/or travel time. Our privacy policies are available at www.bostonwhaler.com.

ASSIGNMENT OF COMPONENT WARRANTIES

Except as expressly set out herein, all warranties provided by the manufacturers and distributors of components, equipment, and parts on the Boat (collectively “Component Manufacturers”) are hereby assigned to the owner to the extent permitted by the Component Manufacturers, as the owner’s sole and exclusive remedy with respect to such items.

REGISTRATION & WARRANTY TRANSFER POLICY

The limited warranty coverage is activated by the authorized selling dealer registering the sale of a new Boat with Boston Whaler.

The Ten-Year, Three-Year, and One-Year limited warranties are transferable to a subsequent owner, except the one-year Accessory warranty which is not transferrable and this Limited Manufacturer Warranty will not transfer to any new owner of a Boat which has been salvaged and resold, or resold after a declaration of a total loss or a constructive total loss, i.e., the cost of repair exceeds the value of the Boat. The new owner must fill out and submit the online Boston Whaler warranty transfer form, accessible from www.bostonwhaler.com. A copy of the bill of sale will be required to submit with the form. The warranty transfer must be completed within 30 days of purchase. Notwithstanding anything in this Limited Manufacturer Warranty to the contrary, Boston Whaler reserves the right to reject any warranty transfer request for a Boston Whaler Boat that has been damaged, neglected, or otherwise previously excluded from warranty.

MODIFICATIONS & SEVERABILITY

The terms and conditions contained herein, as well as those of any documents prepared in conjunction with the sale of this vessel may not be modified, altered or waived by any action, inaction, or representations, whether oral or in writing, except upon the expressed, written authority of a management level employee of Boston Whaler. The invalidity or unenforceability of any one or more of the provisions herein shall not affect the validity and enforceability of the other provisions.

GOVERNING LAW AND VENUE

This Warranty shall be interpreted and construed according to and governed by the laws of the State of Tennessee, without regard to conflict of law principles. Venue for any and all disputes arising out of or related to this Warranty, including without limitation the interpretation, performance or breach of this Warranty, shall be solely and exclusively before the United States District Court for the Eastern District of the State of Tennessee. The parties consent to the in personam jurisdiction of said court for the purposes of any such litigation and waive, fully and completely, any right to dismiss and/or transfer any action pursuant to 28 U.S.C. Section 1404 or 1406 (or any successor statutes) or the doctrine of forum non conveniens. If the United States District Court does not have subject matter jurisdiction of said matter, then such matter shall be litigated solely and exclusively before the appropriate state court of competent jurisdiction located in Knox County, Tennessee, and the parties consent to the personal jurisdiction of such court for the purpose of such litigation.



SAFETY

It is your responsibility (as well as the responsibility of any other operator of this Boat) to be familiar with and observe all local, state and federal laws, rules and regulations regarding boating, navigation and boating safety. You and any other operator of this Boat should take a course in boating and boating safety before operation of this Boat and should be completely familiar with all systems regarding safe operation of this Boat. Personal flotation devices should be worn by each passenger in accordance with U.S. Coast Guard standards and state and federal law.

World Headquarters
100 Whaler Way, Edgewater, FL 32141
(386) 428-0057
www.bostonwhaler.com

BOSTON WHALER LIMITED MANUFACTURER WARRANTY (Outside the U.S. or Canada)

Boston Whaler, Inc. (“Boston Whaler”) provides the following Limited Manufacturer Warranty to the original retail owner of its 2025 model year Boats, that if purchased from an authorized Boston Whaler dealer and operated under normal, non-commercial use, the authorized dealer will repair or replace, at its sole discretion, any defect in material or workmanship in the Boston Whaler Boat that is reported within the applicable Limited Manufacturer Warranty periods and within the scope as set out below.

Mandatory warranty rights, including a consumer’s mandatory statutory rights, by law are not affected by this Limited Manufacturer Warranty and in particular not limited or excluded. These mandatory legal rights exist regardless of whether a warranty claim occurs or rights are asserted under this Limited Manufacturer Warranty.

SCOPE

This Limited Manufacturer Warranty applies only to Boston Whaler Boats purchased outside of the US and Canada, including the territory of the European Union and Australia, and to recreational use customers only (not commercial users). Commercial use, which voids the Limited Manufacturer Warranty, is defined as any use of the product which generates income, even if the product is only occasionally used for such purposes.

Routine maintenance outlined in the Operation and Maintenance Manual must be timely performed in order to maintain Limited Manufacturer Warranty coverage. This Limited Manufacturer Warranty applies to the following items:

- 1. Ten-Year Structural Hull Limited Warranty:** Any Structural Hull Defect in material or workmanship which is reported within ten (10) years from the date of sale to the original retail owner will be repaired or replaced at Boston Whaler’s sole discretion. The “Hull” shall mean the single fiberglass molded shell and integral structural components. A Structural Hull Defect shall mean a substantial defect in the Boat’s Hull which causes the Boat to be unfit or unsafe for general use as a pleasure craft under normal operating conditions
- 2. Three-Year Limited Warranty on Components Manufactured or Installed By Boston Whaler (not applicable to 13 Super Sport or 16 Super Sport models):** Boston Whaler will repair or replace, at its sole discretion, any components manufactured or installed by Boston Whaler that are defective in factory materials and/or workmanship, which are reported within three (3) years from the date of sale to the original retail owner, and are not addressed in the specific warranties listed in paragraphs 1 or 4 or set out in the Exclusions paragraph below.
- 3. One-Year Limited Warranty on Accessory Components for the 13 Super Sport and 16 Super Sport Models:** Boston Whaler provides the following Limited Warranty to the original retail owner of any factory-authorized accessory for the 2025 model year 13 Super Sport and 16 Super Sport, if purchased from an authorized Boston Whaler Dealer, authorized Boston Whaler website or any Boston Whaler affiliate and utilized under normal, non-commercial use (“Accessory”), subject to the remedies, exclusions, and limitations set out below. Boston Whaler will repair or replace, at its sole discretion, any Accessory that is defective in material or workmanship, which is reported within one (1) year from the date of sale to the original retail owner. Boston Whaler is not responsible for any defect and/or damage to the Accessory and/or the Boat caused by improper installation, whether performed by the retail consumer, dealer or any other third party.
- 4. One-Year Limited Warranty on Upholstered Items, Canvas, Teak, and Powder Coating:** Boston Whaler will repair or replace, at its sole discretion, any upholstered items, canvas, teak, and powder coating manufactured or installed by Boston Whaler that are defective in factory materials and/or workmanship and are reported within one (1) year from the date of sale to the original retail owner.

- 5. Limited Engine Warranty:** Retail owners will be entitled to the limited engine warranty as provided in the warranty manual from the engine manufacturer that was delivered to the original retail owner with his or her Boston Whaler Boat.

EXCLUSIONS

This Limited Manufacturer Warranty does not apply to any Boat which has been salvaged or declared a total loss or constructive total loss for any reason not covered in this limited warranty. This warranty also does not apply to the following items:

- 1) Expenses for hauling out, transportation to and from the dealer or the Boston Whaler factory for warranty service.
- 2) Equipment or accessories which are not installed by Boston Whaler or which carry their own individual warranties, including but not limited to engines, engine components, batteries, propellers, controls, steering mechanisms, and electronics.
- 3) Damage, deterioration, discoloration or mold of cushions or cosmetic surface finishes, including scratches, gouges, chips, chalking, blistering, cracking, crazing, fading or oxidation of gel coat, stress lines, plated or painted metal and stainless steel finishes, plastics or acrylic materials, or anti-fouling bottom paint.
- 4) Windshield breakage and leakage.
- 5) Any Boston Whaler Boat initially sold at retail by a party other than an authorized Boston Whaler dealer.
- 6) Damage resulting from abuse, misuse, improper rigging and installation by an owner or any other person or entity not being an authorized dealer, accidents, overloading or powering in excess of the recommended maximum horsepower.
- 7) Failure of the owner to use, maintain, or store the Boat as specified in the Boston Whaler owner's manual; and any other failure to provide reasonable care and maintenance. Normal wear and tear maintenance items are excluded from warranty coverage including but not limited to filters, bulbs, batteries, bungees, wiper blades, anchor rope, trailer finishes, tires, brakes, bearings and lights.
- 8) Damages due to failure to properly tow the Boat. For those Boats for which Boston Whaler offers a yacht tender package, damage due to towing when the package has not been installed.
- 9) Any Boston Whaler Boat which has been altered or modified from Boston Whaler factory specifications, including penetration of the hull by anyone other than Boston Whaler factory personnel or Boston Whaler authorized dealer service personnel following factory specified procedures.
- 10) Damage resulting from use of improper trailer, improperly placed supporting bunks or slings, incorrect bunks placement and improper Boat lift or sling.
- 11) Any Boston Whaler Boat used for commercial purposes, which includes, but is not limited to, any for-profit or other revenue-generating uses.
- 12) Any representation or implication relating to speed, range, fuel consumption or estimated performance characteristics.
- 13) Any failure or defect caused by an act of nature resulting in damage, cost, or expense;
- 14) Any failure or defect arising from a previous repair made by a non-authorized service provider.
- 15) Any item exceeding the expressed coverage limits specified in any Boston Whaler Limited Manufacturer Warranty.
- 16) Failure of the owner to use, maintain, or store an Accessory in reasonable fashion; and any other failure to provide reasonable care and maintenance.
- 17) Any Accessory which has been altered or modified from Boston Whaler factory specifications.
- 18) Any Accessory not purchased from an authorized Boston Whaler Dealer, authorized Boston Whaler

website, or authorized Boston Whaler affiliate. For a list of Boston Whaler's affiliates, please refer to www.brunswick.com.

19) Any Accessory used for commercial purposes, which includes but is not limited to, any for-profit or other revenue generating uses.

20) Any defect or repair requiring redesign of the Boat, except pursuant to the recall provisions of the United States Federal Boat Safety Act of 1971 or the recall laws of any other foreign jurisdiction.

ENVIRONMENTAL POLICIES

In keeping with environmental policies and practices, Boston Whaler reserves the right to utilize reconditioned, refurbished, repaired or remanufactured products or parts in the warranty repair or replacement process. Such products and parts will be comparable in function and performance to an original product or part and warranted for the remainder of the original warranty period.

ACCESS FOR SERVICE

The owner must provide Boston Whaler with a reasonable opportunity to repair, and reasonable access to the Boston Whaler Boat for warranty service. Warranty claims shall be made by delivering the Boston Whaler Boat for inspection to a Boston Whaler dealer authorized to service the product. If the owner cannot deliver the product to such a dealer, written notice must be given to Boston Whaler. Boston Whaler will then arrange for the inspection and any covered repair and the owner shall pay for all related transportation charges and/or travel time.

STATUTE OF LIMITATIONS

Without prejudice to your mandatory statutory rights, any action for rescission or revocation against Boston Whaler shall be barred unless it is commenced within one (1) year from the date of accrual of such cause of action, unless a longer period is prescribed by local law. This section shall not apply to Boston Whaler Boats purchased in Australia.

ASSIGNMENT OF COMPONENT WARRANTIES

Except as expressly set out herein, all warranties provided by the manufacturers and distributors of components, equipment, and parts on the Boat (collectively "Component Manufacturers") are hereby assigned to the owner to the extent permitted by the Component Manufacturers, as the owner's sole and exclusive remedy with respect to such items.

OWNER'S OBLIGATIONS

To initiate a warranty claim, it is the responsibility of the owner to contact an authorized Boston Whaler dealer immediately after discovery of any defect, describe the nature of the problem, and provide a hull serial number, date of purchase, and name of selling dealer. The authorized dealer will notify Boston Whaler, who is solely responsible for determining and authorizing in writing the remedial action(s) to be performed at either an authorized Boston Whaler dealership chosen by Boston Whaler or at the Boston Whaler factory. The owner should notify Boston Whaler of any Boat being repaired by an authorized Boston Whaler dealer which has been at the dealership for fifteen (15) days, or of any claimed defect which was not corrected after one repair attempt. Our privacy policies are available at www.bostonwhaler.com.

REGISTRATION & WARRANTY TRANSFER POLICY

The limited warranty coverage is activated by the authorized selling dealer registering the sale of a new Boat with Boston Whaler.

The Ten-year, Three-year, and One-year Limited Warranties are transferable to a subsequent owner, except

the One-year Accessory Warranty which is not transferrable, and this Limited Manufacturer Warranty will not transfer to any new owner of a Boat which has been salvaged and resold, or resold after a declaration of a total loss or a constructive total loss, i.e., the cost of repair exceeds the value of the Boat. The new owner must fill out and submit the online Boston Whaler warranty transfer form, accessible from www.bostonwhaler.com. A copy of the bill of sale will be required to submit with the form. The warranty transfer must be completed within 30 days of purchase. Notwithstanding anything in this Limited Manufacturer Warranty to the contrary, Boston Whaler reserves the right to reject any warranty transfer request for a Boston Whaler Boat that has been damaged, neglected, or otherwise previously excluded from warranty.

MODIFICATIONS & SEVERABILITY

The terms and conditions contained herein, as well as those of any documents prepared in conjunction with the sale of this vessel may not be modified, altered or waived by any action, inaction, or representations, whether oral or in writing, except upon the expressed, written authority of a management level employee of Boston Whaler. The invalidity or unenforceability of any one or more of the provisions herein shall not affect the validity and enforceability of the other provisions.

SAFETY

It is your responsibility (as well as the responsibility of any other operator of this Boat) to be familiar with and observe all local, state and federal laws, rules and regulations regarding Boating, navigation and Boating safety. You and any other operator of this Boat should take a course in Boating and Boating safety before operation of this Boat and should be completely familiar with all systems regarding safe operation of this Boat. Personal flotation devices should be worn by each passenger in accordance with applicable standards and state and federal law.

THE FOLLOWING SECTION IS APPLICABLE TO EMEA CONSUMERS ONLY

Boston Whaler Boats come with guarantees that cannot be excluded under EU and/or local Consumer Law. For the avoidance of doubt, the Boston Whaler Limited Manufacturer Warranty does not in any way adversely affect any possible right and/or protection the retail owner may have under said applicable legislation.

THE FOLLOWING SECTION IS APPLICABLE TO AUSTRALIAN CONSUMERS ONLY

Boston Whaler Boats come with guarantees that cannot be excluded under the Australian Consumer Law. Retail owners are entitled to a replacement or refund for a major failure and compensation for any other reasonably foreseeable loss or damage. Retail owners are also entitled to have the goods repaired or replaced if the goods fail to be of acceptable quality and the failure does not amount to a major failure.

This Limited Manufacturer Warranty does not cover any expenses that retail owners may incur claiming the warranty.

The benefits to retail owners given by this Limited Manufacturer Warranty are in addition to other rights and remedies of the consumer under a law in relation to the goods or services to which the Limited Manufacturer Warranty relates.

**World Headquarters
100 Whaler Way, Edgewater, FL 32141
011 1 (386) 428-0057
bostonwhaler.com**

**CALIFORNIA EVAPORATIVE EMISSIONS
CONTROL SYSTEM WARRANTY STATEMENT**

YOUR WARRANTY RIGHTS AND OBLIGATIONS

The California Air Resources Board and Boston Whaler, Inc. are pleased to explain the evaporative emission control system's warranty on your 2025 MY spark-ignition marine watercraft (SIMW). In California, new spark-ignition marine watercraft must be designed, built, and equipped to meet the State's stringent anti-smog standards. Boston Whaler, Inc. must warrant the evaporative emission control system on your spark ignition marine watercraft for the period listed below provided there has been no abuse, neglect, or improper maintenance of your spark-ignition marine watercraft.

Your evaporative emission control system may include parts such as: carburetors, fuel tanks, fuel lines, fuel caps, valves, canisters, filters, vapor hoses, clamps, connectors, and other associated components.

MANUFACTURER'S WARRANTY COVERAGE:

This evaporative emission control system is warranted for three years. If any evaporative emission-related part on your spark-ignition marine watercraft is defective, the part will be repaired or replaced by Boston Whaler, Inc.

OWNER'S WARRANTY RESPONSIBILITIES:

- As the spark ignition marine watercraft owner, you are responsible for performance of the required maintenance listed in your owner's manual. Boston Whaler, Inc. recommends that you retain all receipts covering maintenance on your SIMW, but Boston Whaler, Inc. cannot deny warranty solely for the lack of receipts.
- As the SIMW owner, you should however be aware that the Boston Whaler, Inc. may deny you warranty coverage if your spark-ignition marine watercraft or a part has failed due to abuse, neglect, or improper maintenance or unapproved modifications.
- You are responsible for presenting your spark-ignition marine watercraft to a Boston Whaler, Inc. distribution center or service center as soon as the problem exists. The warranty repairs should be completed in a reasonable amount of time, not to exceed 30 days. If you have a question regarding your warranty coverage, you should contact Boston Whaler, Inc. at 1- 877-294-5645.

SIMW EVAPORATIVE EMISSIONS WARRANTY PARTS:

| | |
|--------------------|--|
| Fuel tank | Grade Valves |
| Fuel feed hoses | Fuel Fill Deck Plate w/Cap and Pressure Relief Valve |
| Fuel Line Fittings | Hose Clamps on Fuel System Components |
| Fuel Demand Valves | Fuel Level Vent Valve |

All other parts not listed that may affect the evaporative emissions control system.

PRIVACY STATEMENT

Thank you for purchasing a boat or requesting information from Boston Whaler. This Privacy Statement is to inform you how we collect, use, disclose, and safeguard the personal information you provide to us through your purchases, requests for brochures, product registration cards, promotions, surveys, call centers, or other customer contacts. To see our full Privacy Policy and any updates, please visit www.bostonwhaler.com and select the Privacy Statement link.

“Personal information” may include your name, age, mailing address, residential phone number, or e-mail address. It may also include income ranges, marital status, product or lifestyle preferences, and information concerning dealer service.

How we collect personal information: Our authorized dealer provided Boston Whaler or our company in the European Union with personal information collected at the time of your boat order/purchase with other product registration data and will continue to provide warranty and servicing information on your boat. We will send you customer satisfaction surveys which you may elect to return to provide us with information on your boat purchase and your servicing needs. Your personal information may be gathered by or shared with Boston Whaler’s marketing providers and affiliated companies, who have comparable levels of privacy protection, for the purposes described in this statement. Boston Whaler, your dealer, and our marketing providers collect personal information when you request information about our companies and from surveys, promotions, contests, correspondence, your e-mails, telephone inquiries, web forms, and other communications.

How We Use and Disclose Personal Information: Unless you advise us otherwise, Boston Whaler, our authorized dealers, affiliated companies, and our marketing providers may generally collect, use, disclose, hold, and file your personal information for the following purposes: (1) Providing goods, brochures, information, incentives, and/or services to you or on your behalf; (2) Fulfilling the terms of our limited warranty or other service obligation; (3) Facilitating recalls or service campaigns if necessary; (4) Reviewing goods and/or services provided to you in product, services, and marketing analyses; (5) Ensuring your satisfaction through surveys or other contacts; (6) Administration, billing, accounting, and collections; and protecting against fraud and error; and (7) Investigating a breach or a contravention of a law, complying with a subpoena, warrant, court order, or as required or otherwise permitted by law. **BOSTON WHALER WILL NOT SELL YOUR PERSONAL INFORMATION OR SUBJECT YOU TO TELEMARKETING OR UNSOLICITED E-MAIL.**

Safeguards: We use security safeguards appropriate to the sensitivity of personal information to protect it from loss or theft, as well as prohibiting unauthorized access, disclosure, copying, use or modification of your personal information. These safeguards include restricted access to offices and equipment, security clearances, the use of passwords and/or encryption, publishing our privacy policy to appropriate personnel with instructions to act in accordance with its principles, and contractual provisions with our marketing agents and authorized dealers to follow the principles of our privacy policy.

Access and correction to your personal information: Subject to the exceptions provided by applicable law, we will provide, upon written request, your specific personal information collected in a form which is generally understandable. Your Personal Information is held by us and for us by our marketing agency, AVALA, who has contractually agreed to protect your information according to our privacy policies at the following addresses: Boston Whaler Inc., 100 Whaler Way, Edgewater, FL 32141. Please direct corrections, withdrawal of consent for specific purpose, complaints or other inquiries regarding personal information to: Terry Domain, AVALA Marketing Group 1078 Headquarters Park Drive, Fenton, MO, 63026; phone: (636) 343-9988, fax: (636) 326-3282. E-mail: terryd@MarketingAgencymarketing.com. You can withdraw consent for us to use your personal information at any time or provide corrections upon providing to us a 30-day notice, unless withdrawing consent would impede the performance of legal obligations. We are required by law to provide you with information for product recall and other product safety related purposes. The withdrawal of your consent may also adversely affect our ability to provide products and services to you and to maintain our relationship. Please note, notifying us will not result in withdrawing consent from your dealer, who should be contacted separately.

Obtaining consent: If any supplementary disclosure is required, we will obtain your consent for disclosure to other persons or organizations and for other purposes than stated herein, unless otherwise permitted by law.

Thank you for your business. We hope you have many years of wonderful boating experiences!

Owner's Manual

The material here and in the rest of the Owner's Manual Packet:

- Gives you basic safety information;
- Describes the features of your boat;
- Describes the equipment on your boat;
- Describes the fundamentals of boat use; and
- Contains service and maintenance information.

You must learn to operate this boat as well as read, understand and use this manual.

What this manual **does not** give you is a course in boating safety, or how to navigate, anchor or dock your boat. Operating a power boat safely requires more skills, knowledge and awareness than is necessary for a car or truck.

Your Responsibilities

For your safety, the safety of your passengers, other boaters and people in the water, you must:

- Take a boating safety course;
- Get instruction in the safe and proper handling of your boat;
- Understand and follow the "rules of the road";
- Learn how to navigate.

Source of Information

In North America, contact one of the following for boating courses:

- U.S. Coast Guard Auxiliary
- U.S. Power Squadron
- Canadian Power and Sail Squadrons
- Red Cross
- State Boating Offices
- Yacht Club

Contact the Boat/U.S. Foundation at 800-336-2628 or go to www.boatus.com/foundation

Outside of North America, contact your boat dealer and/or your governmental boating agency for assistance.

A comprehensive background in boating can be found in the book, *Chapman - Piloting, Seamanship and Small Boat Handling*, by Elbert S. Maloney, published by Hearst Marine.

Warranties

In addition to the Boston Whaler® Limited Warranty for your boat, each component and/or system on your boat has its own warranty that will be found with the specific information and manual for that component. The manuals are included with your Owner's Manual Packet. Locate and read the individual warranties, then keep them together for easy future reference.

Contact Information

Boston Whaler, Inc.

877-294-5645

www.bostonwhaler.com

United States Coast Guard

800-368-5647

www.uscgboating.org

Boat US Foundation

800-336-2628

www.boatus.com/foundation

Canadian Coast Guard

800-267-6687

www.ccg-gcc.gc.ca/

Explanation of Safety Labels

The most important aspect of boating is safety. Although every effort is made to address the numerous issues regarding the safe usage of your boat, it is strongly recommended that you avail yourself of the training and knowledge available through boating safety courses, etc.

Warning Labels

Mounted at key locations throughout your boat are warning labels (See page 1-19) which advise the owner/operator of imperative safety precautions to follow when operating and/or servicing equipment.

The examples below indicate the level of hazard by color and explanation.



DANGER

Denotes an immediate hazard exists that **WILL** result in severe personal injury or death.



WARNING

Denotes hazards or unsafe practices that **MAY** result in severe personal injury or death.



CAUTION

Denotes hazards or unsafe practices that **COULD** result in minor personal injury, product or property damage.



NOTICE

Denotes information that is important to know prior to operation and/or maintenance, but is not hazard related.

Safety Precautions

The examples below are of precautions which appear throughout this manual and must be observed when operating or servicing your boat. Learn to recognize the degree of hazard and understand the explanations of safety prior to reading this manual.

Always use common sense in the operation and servicing of your boat.



DANGER

Denotes an immediate hazard exists that **WILL** result in severe personal injury or death.



WARNING

Denotes hazards or unsafe practices that **MAY** result in severe personal injury or death.



CAUTION

Denotes hazards or unsafe practices that **COULD** result in minor personal injury, product or property damage.

NOTICE

Denotes information that is important to know prior to operation and/or maintenance, but is not hazard related.

SAFE Boating means:

- Knowing the limitations of your boat
- Following the “RULES of the ROAD”
- Keeping a sharp lookout for people and objects in the water.
- Not boating in water or weather conditions that are beyond the boat’s and operator’s capability.
- Never operating the boat while under the influence of drugs or alcohol.
- Being aware of your passengers safety at all times.
- Reducing speed when there is limited visibility, rough water, people in the water nearby, boats or structures.

In Addition:

- Maintain your boat and its safety and other systems as recommended in this manual.
- Have the boat inspected by a qualified mechanic or dealer, at least annually.
- Ensure that the Coast Guard required safety equipment is on board and functioning.

NOTICE

As a boat owner or operator, YOU are responsible for your safety and the safety of your passengers and other boaters.

Boating in beautiful weather and calm water conditions can be a wonderful experience. Boating however requires considerably greater skills than operating a land vehicle. Taking a boating course is the best way to prepare for a safe and enjoyable experience on the water.

- Take a Coast Guard, U.S. Power Squadron or equivalent boating safety course. (Call the Boat/U.S. Foundation at 1-800 336-2628 for information on available courses, or go to: “www.boatus.com/foundation” on the internet.)
- Get hands-on training on how to operate your boat properly.

Safe Boating Checklist

Before Departure

- Update checklists when equipment is added or modified.
- Weather-forecast safe
- Required documents-on board
- Navigation charts & equipment-on board
- Safety equipment-on board
- Safety training-passengers & crew instructed on procedures, location, and use of safety equipment.
- Drain plugs-installed
- Bilge pumps-working & clean
- Navigation lights-working
- Sound signal device on board
- Fuel system-no leaks or fumes
- Power steering fluid-filled (if applicable)
- Steering system-working smoothly & properly
- Battery-electrolyte level within range
- Float plan-filed with friend or relative

Trailing (if applicable)

- Boat position-secure on trailer
- Tiedowns-tight
- Winch-locked
- Trailer hitch-connected
- Safety chains-attached
- Swing tongue-secured with safety clip
- Engine clearance-in trailering position (See engine manual for recommended guidelines)
- Electrical-Lights, brake lights, turn signals working
- Mirrors-adjusted for trailering

After Return

- PFD’s & other safety gear-dry, stowed for next use
- Fuel tanks-filled (allow for expansion) to prevent condensation
- Fuel system-no leaks
- Bilge pump-operating properly
- Bilge-clean, no leaks
- Float plan-notify person with whom you filed plan

General Considerations

- Know how your boat handles under different conditions. Recognize your limitations and the boat's limitations. Modify speed in keeping with weather, sea and traffic conditions.
- Instruct passengers on location and use of safety equipment and procedures.
- Instruct passengers on the fundamentals of operating your boat in case you are unable to do so.
- You are responsible for passenger's actions. If they place themselves or the boat in danger, immediately correct them.
- Remember the "Rule of Thirds": one third total fuel usage for the trip out; one third total fuel usage while out; one third total fuel usage for the return trip.

Maintain Control

On the water there are no marked traffic lanes, no traffic signs or lights, and boats have no turn signals. The boat operator must keep her or his attention focused not only on what's ahead but what's on the left, right and behind the boat.

The operator must always be alert to approaching boats (from the rear, right and left sides, as well as those ahead). There can be people in the water, partially submerged debris, and other navigational hazards such as rocks, sand bars or dangerous currents, to name a few.

Your passengers are relying on you to operate and maneuver the boat safely so that they are not in danger of going overboard. If you turn too quickly, increase or decrease speed abruptly, your passengers are at risk of being thrown overboard or thrown about the boat.

When visibility becomes impaired because of weather, time of day or high bow angle you must slow down so that you have sufficient time to react if an emergency occurs. Nearby boats face similar risks in avoiding a collision with you.

Boarding

- Board only one person at a time.
- Never jump into boat. Step or climb into cockpit.
- Load gear after you are aboard. Carrying gear while boarding can cause you to lose balance.
- Distribute weight evenly.
- Instruct passengers where to sit during on-plane operation to reduce the possibility of falling overboard during high speed maneuvers.
- If gear is not immediately needed, stow it in secure areas.
- Safety gear must be immediately accessible at all times.

Impaired Operation

WARNING

CONTROL HAZARD-Federal laws prohibit operating a boat while under the influence of alcohol or drugs. These laws are vigorously enforced.

The detrimental effects of alcohol and drugs are increased by wind, waves and sun, and will decrease your response time and ability to act in critical situations. Give special attention to the effects of alcohol and drugs while boating. No other single factor causes as many marine accidents and deaths. Death or serious injury and damage to personal and private property can result from being impaired while operating a boat.

WARNING

A qualified operator must be in control of the boat at all times. Do not operate the boat while under the influence of alcohol or drugs. Never operate your boat at speeds which exceed the operator's ability to react if an emergency develops. At night, turn on the appropriate navigation lights and cruise at a reduced speed that will allow you plenty of time to avoid dangerous situations.

WARNING

Death or serious injury can result if you fail to observe these safety rules:

- Anyone who controls the boat should have taken a boating safety course and have trained in the proper operation of the boat.
- Always operate the boat at speeds that will not put people or property in danger.
- Be constantly aware of conditions in all directions when underway and before turning.
- Reduce speed, use a lookout to identify possible hazards or difficulties, and turn on navigation lights when:
 - visibility is impaired;
 - in rough water; and
 - in congested waterways.
- Watch your wake. It can capsize a small boat or damage moored boats or other property. You are responsible for damage caused by your wake.

WARNING

NEVER operate a boat at a speed at which you do not feel in control.

WARNING

STABILITY HAZARD

- Load boat properly. The manufacturer's load rating is the maximum allowed under normal conditions. Adjust downward if weather, water or other conditions are adverse.
- Allow passengers to ride only in areas that do not pose a hazard to themselves or the boat.

DO NOT allow passengers to ride on the bow of a closed bow boat.

DO NOT allow several passengers to ride in the bow of a small open-bow boat, causing the boat to "plow" into the water.

DO NOT allow passengers to ride on the transom or gunwales.

DO NOT overload the stern.

- Observe manufacturer's recommended seating and on-plane locations (See page 2-10).
- Passengers should remain seated while boat is moving.

PERSONAL INJURY HAZARD-Stay alert. Use of drugs, alcohol, or other substances which impair judgement poses a serious threat to yourself and others. The boat operator is responsible for the behavior of passengers.

DROWNING HAZARD-Boats must carry one wearable personal flotation device (PFD) for every passenger on board. Boats must have at least one throwable life preserver.

SLIPPING HAZARD-Wet decks are slippery. Wear proper footwear and use extreme caution on wet surfaces.

Legally Mandated Equipment (Minimum Required)

Consult your national and state boating law enforcement agency.

The following equipment is the minimum required by the U.S. Coast Guard for a boat less than 26' (7.9 meters) in length.

Personal Flotation Devices (PFD's)

- One (1) Coast Guard approved Type I, II or III PFD for each person aboard or being towed on water skis, tubes, etc.

WARNING

There is rarely time to reach stowed life jackets in time of emergency. Boaters should always wear a properly fitting, approved life jacket when on the water.

Children and non-swimmers MUST wear PFDs at all times when aboard.

NOTICE

Depending on the state or country of operation, the operator of a vessel may be fined for failure to comply with local or national rules regarding PFD usage.

Fire Extinguisher (Portable)

The American Boat & Yacht Council (ABYC) recommends one 5-B type ABC portable fire extinguishers be on board and located within easy reach of helm..

Whistle, Horn

You must have on board, some means of making a loud sound signal. Navigation rules require that a sound made by any audible device be capable of a four (4) second blast, and must be audible for 1/2 mi. (.80 Km).

Visual distress Signals

Boats operating in coastal waters, the Great Lakes & US owned boats on the high seas are required to carry approved visual distress signals for nighttime use. They must be readily accessible, in serviceable condition and not be expired.

Store all pyrotechnic signals in a well marked, waterproof container.

Additional Recommended equipment for safe operation

In addition to the legally mandated equipment, the following items are recommended for safe boating.

- First Aid kit
- Charts/Maps
- Visual distress signals (for day or night use)
- Marine VHF radio
- Moisture repellent
- Mooring Lines
- Fenders
- Waterproof flashlights
- High power spotlight
- Spare propeller
- Tool kit:
 - Screwdrivers, (Phillips & flat)
 - Pliers, (regular, vise-grip, tongue & groove)
 - Wrenches, (box, open end, allen & adjustable)
 - Socket set, (metric and U.S.)
 - Electrical tape & duct tape
 - Hammer
 - Spare parts kit, (spark plugs, fuses, etc.)
- Compass
- Manual bilge pump
- GPS or LORAN
- Spare keys
- EPIRB-Emergency positioning-indicating radio beacon
- Boat hook
- Extra batteries
- Instruction manuals
- Lubricating oil

Carbon Monoxide (CO)

⚠ DANGER

- **Fumes from the engine(s), Generator(s) and other equipment and appliances that burn fuel contain Carbon Monoxide. Carbon Monoxide can kill you. Open all doors, hatches, curtains and windows to allow fresh air to circulate and dissipate the amounts of Carbon Monoxide present in enclosed spaces, especially when the boat is moored or anchored.**
- **Proper ventilation must be maintained, even during inclement weather to prevent dangerous levels of Carbon Monoxide build-up.**
- **Sleeping aboard a boat will require a working Carbon monoxide detection system, preferably in each sleeping quarter.**

Carbon Monoxide is an odorless, colorless, and tasteless, extremely toxic gas produced by engines, heaters, stoves or generators. When inhaled it combines with hemoglobin in the blood, preventing absorption of oxygen and is unlikely to be noticed until the person is overcome.

Prolonged exposure to low concentration or very short exposure to high concentrations can result in asphyxiation and death.

Symptoms of Carbon Monoxide poisoning include:

- Dizziness
- Headaches
- Ringing in the ears
- Nausea
- Unconsciousness

GET MEDICAL ATTENTION AS SOON AS POSSIBLE.

Symptoms of CO poisoning are often confused with seasickness or intoxication, so those affected may not receive the medical attention they need.

The poisoning victim's skin often turns cherry red. If CO poisoning is suspected, have the victim breathe fresh air deeply. If breathing stops, resuscitate. A victim often revives, then relapses because organs are damaged by lack of oxygen.

Carbon Monoxide can accumulate in dangerous concentrations anywhere in or around your boat including on back decks, swim platforms, or in water around exhausts. CO can remain in or around your boat at dangerous levels even if your engine is no longer running.

Remember:

- If you can smell engine exhaust, you are inhaling CO.
- Changing course and speed to place boat heading into the wind can improve ventilation.

To minimize the danger of Carbon Monoxide accumulation when the Engine is running (or by use of fuel burning equipment.):

- Do not idle the engine without moving the boat for more than 15 minutes at a time.
- Inspect the exhaust system regularly.
- Operate all fuel burning appliances, such as charcoal, propane, LPG, CNG or alcohol cooking devices in areas where fresh air can circulate.

In the event the CO alarm activates:

- Evacuate enclosed areas immediately.
- Shut OFF any fuel burning equipment or appliances.
- Open hatches, doors, portlights, etc. to improve ventilation.
- If making way, head boat into the wind.

⚠ DANGER

Never ignore an alarm.

⚠ DANGER

Even in rainy cold weather, ventilation must be maintained to avoid Carbon Monoxide poisoning. You will get wet and/or cold.

Examples of accumulation of Carbon Monoxide
Fig. 1.7.1

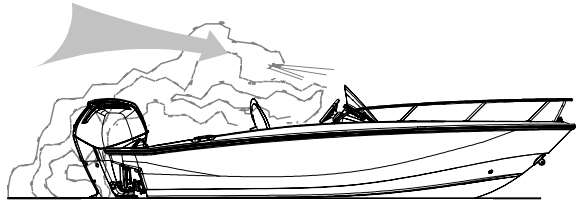

WINDS BLOWING EXHAUSTS TOWARD BOAT OCCUPANTS.

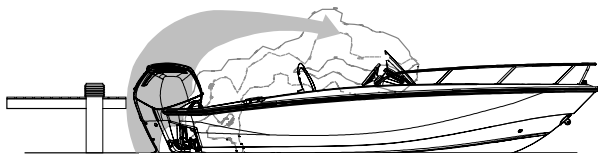

BLOCKING EXHAUSTS

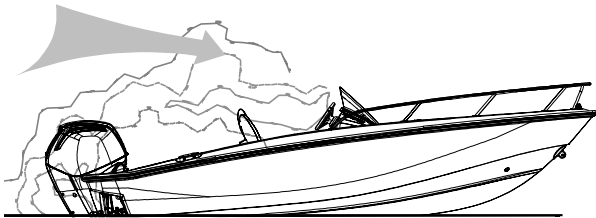

OPERATING WITH "BOW HIGH"

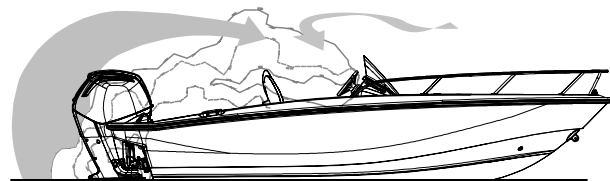

OPERATING AT SLOW SPEED
OR DEAD IN WATER

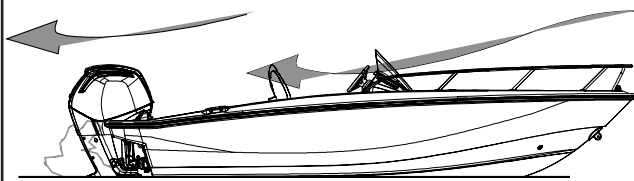

GOOD AIR FLOW

Lifesaving Equipment

Even strong swimmers can tire quickly in the water and drown due to exhaustion, hypothermia, or both. The buoyancy provided by a personal flotation device (PFD) will allow the person who has fallen overboard to remain afloat with far less effort and body heat loss, extending survival time necessary to find and retrieve them.

PFD Requirement

One (1) Coast Guard approved PFD, Type I, II or III for each person aboard or being towed on water skis, tubes, etc.

The law requires that PFDs must be readily accessible, if not worn. "Readily Accessible" means removed from storage bags and unbuckled.

NOTICE

Children and non-swimmers MUST wear PFDs at all times when aboard.

PFD Classifications

Listed below are the several different types of PFDs, each life jacket has different purposes, choose one that will suit your purpose.

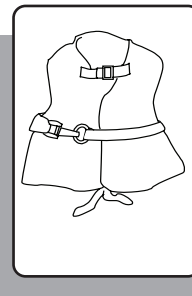

Type I, Off-shore Life Jacket is considered the most buoyant, it is designed to turn an unconscious person face up. Use in all types of waters where rescue may be slow, particularly in cold or rough water conditions.

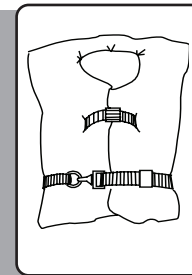

Type II, Near-shore Life Vest, "keyhole" vest with flotation filled head and neck support is also designed to turn a person face up, but the turning action is not as pronounced. Use in calm inland waters or where quick rescue is likely.

Section 1 • Safety

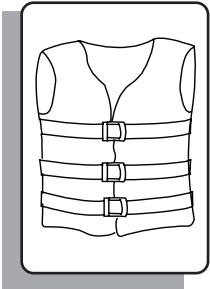

Type III, Flotation-aid Life vest is designed so that conscious wearers can turn face-up. Often designed for comfort while engaged in water skiing or other forms of water activities.

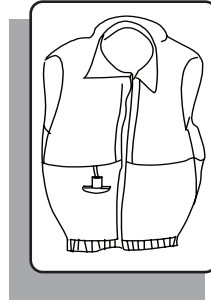

Type V, Special-Use devices, sailboat harnesses, white water vests, float coats, and hybrid vests which have minimum inherent buoyancy and an inflatable chamber.

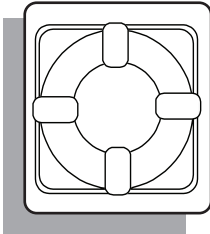

Type IV, Throwable Devices, horseshoe bouys, ring bouys and buoyant cushions are designed to be grasped, not worn.

Before purchasing PFDs, ensure that there is an attached tag indicating they are approved by the U.S. Coast Guard or by your National Boating Law Enforcement Agency.

The operator is responsible for instructing everyone onboard on their location and use. **The best precaution is to wear the PFD at all times while on the boat.**

Emergency Situations

NOTICE

The law requires the operator to assist any person or boat in distress as long as rendering assistance does not endanger the operator, the passengers or the boat.

Prevention is the safest approach. We hope that you are never involved in an emergency situation, but if you are it is imperative that you react.

Medical Emergency

You may be far from professional medical help when you are boating. At least two (2) persons on board your boat should be CPR certified, and should have taken a first aid course. Your boat should have a well stocked first aid kit on board. In many situations your radio will be your only link to reaching medical assistance. Keep the radio in working order and understand which channels are used for emergencies, these channels are constantly monitored and will be useful when situations arise. Cell phones are becoming more common and can help in some areas, but they are limited and unreliable and should not be used in the place of a good VHF radio.

Water Rescue

In most situations a person that has fallen overboard will succumb to hypothermia if not rescued immediately. Life expectancy decreases as rescue time increases in water temperatures below 70° (21.1°C).

There are three (3) steps that must be taken when a person has fallen overboard:

1. Returning to the victim:

- Immediately make everyone onboard aware that someone is overboard and keep the victim in sight.
- Slow the boat and keep pointing toward the person overboard. At night or in low light, point the best available light source at the person.
- Throw a life ring/preserver to the victim, even if they are wearing one it will serve as another marker.

2. Making contact:

- Stop or slow the boat and circle toward the person overboard. Never reverse your boat to pick up someone in the water.
- Try to approach heading into the wind or into the waves.
- Keep person overboard constantly in sight.
- When almost alongside, stop the engine in gear to prevent propeller “windmilling”.

3. Getting back aboard:

- Try to reach the person overboard with a pole, or by throwing a life preserver. NEVER swim to them except as a last resort.
- Assist the person in boarding. Boarding should be done at the stern of the boat.
- If the person is injured or incapable of boarding by themselves, a rescuer should don a life preserver with a safety line and enter the water to assist the person onto the boat.
- Handle the person carefully, spinal injuries might have occurred and could be worsened by rough handling.
- Check for other injuries, render medical assistance immediately.

Unassisted Reboarding

The transom ladder (See page 3-9) can be deployed to accommodate a person reboarding the boat without assistance.

Fire

Fire is a serious boating hazard. Boats will burn quickly. Do not remain onboard and fight a fire for more than a few minutes. If the fire is out of control and cannot be put out with the fire suppression equipment onboard, abandon ship immediately.

The fumes released during a fire are toxic and should be avoided. Even after the fire has been extinguished, proper ventilation of the area is required to minimize exposure to these harmful fumes.

DANGER

- **Fires can spread quickly. Your reaction to the fire is important. Have the proper fire fighting equipment close at hand, and in good working order to respond quickly.**
- **Small fire extinguishers have small discharge times. Aim at the base of the fire with a sweeping motion to maximize the use of the fire extinguisher contents.**

To lessen the danger of fire:

- Extinguish all smoking materials, shut off blowers, stoves, engine(s) and generator(s).
- Keep bilge area clean, oil and fuel spills should be cleaned immediately.
- If possible throw burning materials overboard.
- If fire is accessible, release the contents of the fire extinguisher(s) into the base of the fire.
- If the fire is in an enclosed compartment, and you have an automatic extinguisher for the compartment, wait 15 min. before opening the compartment. Have an extinguisher handy in case of a flare up.
- If possible, signal for help. Radio, visual, or audible signal should be used as needed. You must render assistance to any boater requesting help.
- If fire is out of control, grab all necessary survival gear, distress signals, don your PFD and prepare to abandon ship.
- If you do abandon ship, make sure the passengers have PFDs. Take a head count before entering the water and take another head count when in the water. **STAY TOGETHER.**

Flooding, Swamping and Capsizing

In the event of Flooding, Swamping or Capsizing:

FLOODING

- Always wear your PFD, or have it within reach.

- If the bilge pump(s) have not automatically turned ON, switch them ON immediately.
- Find the source of the flooding and determine the best fix.
- Keep the bilge pump running until the flooding is under control.
- Call for assistance if the source of the flooding cannot be controlled.
- Head back to port if possible.

SWAMPING

- Always wear your PFD, or have it within reach.
- Swamping is usually a result of wave action, immediately get control of the helm and turn the boat into the waves.
- Swamping can also be caused by an overloaded boat.
- If the bilge pump has not automatically turned ON, switch it ON immediately.
- The deck scuppers on your boat are designed to drain the deck of water.
- Keep the bilge pump running until the flooding is under control.
- Take a head count of all passengers.

CAPSIZING

- “Capsized” is when a boat is on its side or completely upside-down (usually as a result of wave action, improper loading or load shifting).
- Always wear your PFD, or have it within reach.
- If the boat will not right itself, get out of the water and climb onto the exposed hull.
- Do a head count of all passengers
- **STAY TOGETHER**
- Usually a capsizing will happen quickly and without warning.
- Use whatever is at hand to signal for help.

The chances of flooding, swamping or capsizing can be reduced by being aware of:

- Weather
- Water Conditions
- Proper boat handling techniques
- Proper loading of the boat

Collision

In the event of collision:

- Cut the engine(s)
- Always wear your PFD, or have it within reach.
- Check on passengers
- If the bilge pump has not automatically turned ON, switch it ON immediately.
- Determine the amount of damage to your boats structure.
- Call for assistance
- In the event of collision you are required to file an accident report. Contact a state enforcement agency or the nearest U.S. Coast Guard office. If you are boating outside U.S. waters, consult the nation you are visiting for accident reporting requirements.

Propulsion, Control or Steering failure

If there is a propulsion, control or steering failure:

- Stop the engine, (shut off at Ignition or pull on the Engine emergency stop switch.)
- Drop anchor to prevent drifting.
- Determine if the problem can be fixed or will assistance be needed.
- Call for assistance if needed

When loss of propulsion or steering is noticed, your quick reaction is required to prevent further damage to your boat or injuries to your passengers.

Outboard engines require propulsion to control the direction the boat will take. Without propulsion, the

steering is virtually useless. If you are in a congested waterway you will need to react quickly to warn others that you have lost power, propulsion or steering control and that assistance will be needed.

Grounding

Running aground may be avoided by paying attention to marker bouys or observing the waves as they form into breakers when passing over a sand bar.

If you do run aground, the course of action depends on how hard the boat hits bottom and whether the boat remains stranded. If it is a simple touch, you may need only to inspect the lower drive of the engine and the hull of the boat. If possible do a thorough inspection before trying to get loose, throwing the boat into reverse before this is done may do more damage.

Distress Signals

VISUAL DISTRESS SIGNALS, (VDS)

- U.S. Coast Guard regulations require boats in coastal waters and the Great Lakes to carry a Visual Distress Signal (VDS) for day and night use, as well as appropriate for the time of operation. Exempt from the day signals requirement, but not night signals, are boats less than 16 feet (4.8 m), open sailboats less than 26 feet (7.9m), boats participating in organized events and manually propelled boats.
- If you are required to have visual distress signals, at least three safety approved pyrotechnic devices in serviceable condition must be readily accessible. They must be marked with a date showing the service life which must not be expired.
- Carry three signals for day use and three for night use. Some pyrotechnic devices such as red flares, meet both day and night use requirements.
- Store pyrotechnic signals in a cool, dry location. An orange or red watertight container prominently marked “DISTRESS SIGNALS” is recommended.

Other recognized visual distress signals include:

- Flames in a bucket
- Code flags November & Charlie displayed together.
- Black square & ball on orange background flag
- Orange flag (certified)
- Electric distress light (certified)-for night use
- Dye marker (any color)
- Person waving arms (slowly)
- U.S. ensign flown upside down

AUDIBLE DISTRESS SIGNALS, (ADS)

U.S. Coast Guard regulations require one hand, mouth or power operated whistle or horn, audible for at least 1/2 mile.

Other recognized audible distress signals include:

- Radio communication (see **Radio Communication** below)
- Radio-telegraph/telephone alarm
- Position indicating radio beacon (EPIRB)
- Morse Code S-O-S (3 short 3 long 3 short) sounded by any means.
- Fog horn sounded continuously.

Radio Communication

A radio is the boat operator's main method of receiving safety information and summoning aid. VHF-FM radio is the primary means of short range communication. Single sideband radio (SSB) is used for longer range communication.

VHF-FM channel 16 and SSB 2182 kHz are designated for emergency use. Such situations can be categorized as:

- **EMERGENCY-**
“MAYDAY, MAYDAY, MAYDAY,”- used when life or vessel is in imminent danger.

- **URGENCY-**

“**PAN-PAN, PAN-PAN, PAN-PAN**” (pronounced PAHN-PAHN)-used when a person or vessel is in some jeopardy less than indicated by a “MAYDAY” call.

- **SAFETY-**

“**SECURITY, SECURITY, SECURITY**” (pronounced SAY-CURE-IT-AY)-used for navigational safety or weather warning.

An emergency situation will be hectic and there will not be time to learn proper radio procedure. **LEARN WHAT TO DO BEFORE YOU NEED TO DO IT.** If you hear a distress call, stop all radio transmissions. If you can directly assist, respond on the emergency frequency. If you cannot assist, do not transmit on that frequency. However, continue to monitor until it is obvious that help is being provided.

Weather

⚠ DANGER

DO NOT attempt to boat in severe weather conditions. Death or serious injury can occur. Get to shore before the weather turns bad.

Getting caught in severe weather is hazardous. Bad weather and/or rough sea or water conditions can cause an unsafe situation. Consult local weather services for up-to-date forecasts on weather and sea conditions. Television, Radio, Internet can give you access to NOAA weather reports that will help you make a determination on where and when to get underway.

Following are some weather related rules:

- Understand the design limitations of your boat.
- Check the weather forecast and water conditions before leaving and while underway.
- Wear a Personal Flotation Device, (PFD).

! WARNING

A sudden change in wind direction or speed or an increase in wave height indicates deteriorating weather.

NOTICE

Check the weather forecast and water conditions before leaving and while underway

Weather Warning Pennants
Fig. 1.13.1

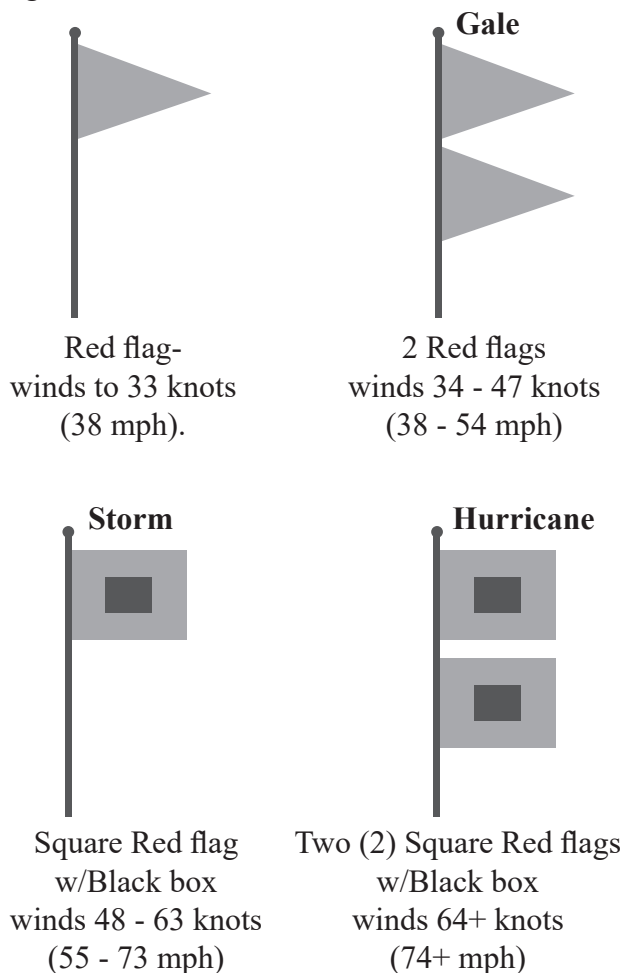

- If a storm approaches, immediately seek a safe harbor.
- If a storm hits have everyone sit in the cabin or cockpit deck in the boat. Head the bow into the wind with enough power to maintain slow headway.

- If you encounter fog, determine your position, set a safe course, slow down and alert other boats of your presence using the appropriate sound signal for your situation at intervals of not more than two minutes apart.
- If a lightning storm approaches, the safest action is to dock and disembark. If you cannot return to shore, have passengers go inside the cabin and remain there until the storm passes.
- Stay out of the water during a lightning storm. If caught swimming during a storm, get back into the boat and remain there until the storm passes. (Remember that lightning can strike several miles away from the storm itself. Be aware of the storm's location relative to your location and the direction the storm is moving).

Swimming, Diving & Water Skiing

Swimming

- Do not swim from a moving boat.
- Many areas prohibit swimming from a boat except in designated areas. Never enter swimming zones.
- Turn off engine in gear (to prevent propeller "windmilling") before picking up swimmer.

Diving

Recognize and respect diving flags. Keep at least 100 feet (30 meters) away.

Diver's Flags
Fig. 1.13.2

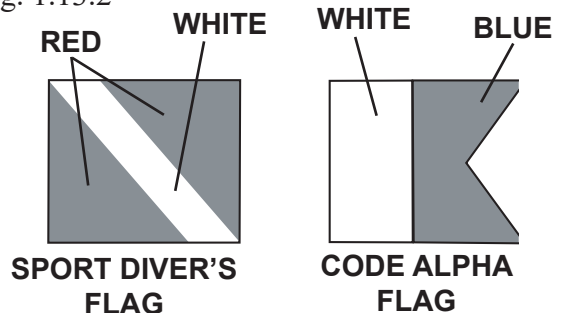

SPORT DIVERS FLAG-Red flag with diagonal white stripe marks a diver in the water.

CODE ALPHA FLAG-Blue and white pennant designates boat being used in dive operations.

Water Skiing

- Always have at least two persons in the boat, one at the controls and one who can easily and continuously look at the skier.
- Insist that anyone who water skis must know how to swim.
- Insist that skiers wear approved Personal Flotation Devices (PFD's)
- Ski only in daylight when visibility is good.
- Never drive the boat directly behind a water skier. At 22 knots (25 m.p.h.) it takes only 5 seconds to overtake a fallen skier who was 60 meters (200 feet) in front.
- Ski only in areas where skiing is permitted.
- Observe local restrictions on length of tow line.
- Learn the signals to communicate with a skier. The skier is to control the boat through hand signals (Figure 1.14.1).
- Your boat will handle differently while towing a skier. Experiment carefully to learn the difference.
- Skiers may start from the shore or dock, if boat traffic allows. When returning, pick up skiers from water. Do not ski back to shore or dock.
- Give immediate attention to fallen skiers.
- Keep a downed skier in sight and on the operator's side of the boat when approaching the skier. **Never back up to anyone in the water.**
- Turn off engine in gear (to prevent propeller "windmilling") before picking up skier.
- If the skier suddenly releases the tow rope, it can backlash into cockpit. Spotters who are watching the skier must be aware of this fact and be prepared to take appropriate action to avoid injury.

Water Skiing Signals

Skiing Signals

Fig. 1.14.1

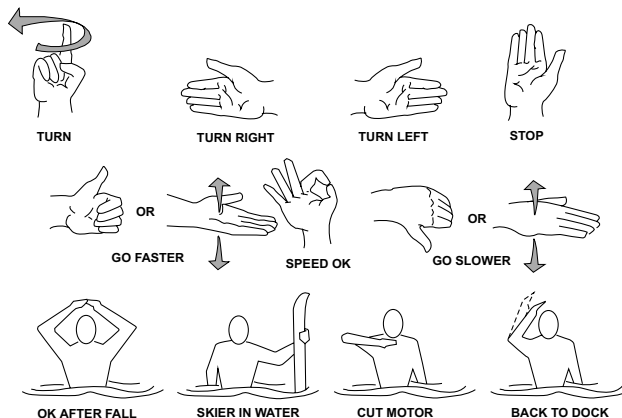

Turn – Arm raised, circle with index finger extended.

Turn Right – Extend arm out from body to the right.

Turn Left – Extend arm out from body to the left.

Stop – Raise arm with palm vertical and facing forward.

Faster – Thumb pointed up or palm up, move hand up and down.

Speed OK – Raise arm and form a circle with thumb and index finger.

Slow Down – Thumb pointed down or palm down, move hand up and down.

OK After a Fall – Clasp hands together overhead.

Skier in Water – Extend one ski vertically out of water.

Cut Motor – Draw finger across throat.

Back to Dock – Pat top of head.

! WARNING

Never allow anyone to board or exit your boat from the water when engines are on.

 **WARNING**

SWIMMING/DIVING HAZARD

- Keep clear of areas designated only for swimmers and skin divers. Recognize markers used for such areas.
- Never swim when there is lightning in the area.

SKIING HAZARDS

- Skiers must use a safety approved Personal Flotation Device (PFD).
- Ski only during daylight and in good visibility.
- Avoid shallow water, other boats, navigational aids and other obstructions.
- Keep at least 100 ft. (30 meters) from other objects.
- Never drive directly behind a water skier.
- A competent observer must watch the skier at all times. A competent observer is a person that has the ability to assess when a skier is in trouble, knows or understands water skiing hand signals and is capable of helping a skier.
- Keep a downed skier in constant sight.
- Turn off engine in gear before you get close to person in the water.
- Never back up to anyone in the water.
- Use caution in boat when skier is being towed. Sudden release of tow rope can cause it to backlash into the cockpit.

PERSONAL INJURY HAZARD

Use transom tow ring only to pull water skiers. Unless specified by the manufacturer, any other use, such as parasailing, kite flying, towing other boats, etc. may create too much stress on the tow ring, resulting in personal injury and/or equipment damage.

 **DANGER**

PROPELLER SAFETY

- Before starting your boat, walk to the stern and look in the water to assure there is no one near your propeller.

People near propeller may not be visible from helm.
- NEVER allow passengers to board or exit your boat from the water when engines are on.
- Educate passengers about the dangers of propellers
- Be especially alert when operating in congested areas. NEVER enter swimming zones.
- Take extra precautions near boats that are towing skiers or tubers.
- NEVER permit passengers to ride on the bow, gunwale, transom, seatbacks, or other locations where they may fall overboard.
- STOP! If someone falls overboard. Slowly turn the boat around, and keep the person in sight as you approach. Turn your engine off FIRST and then bring the person aboard.
- NEVER reverse your boat to pick someone up out of the water.

Emergency Engine Stop Switch

WARNING

Wear the lanyard at all times when operating the boat. Use it to stop only in an emergency. DO NOT use it to shut off the engine during normal operation

The 130 Super Sport is equipped with an Engine emergency stop switch. The switch is located on the throttle and shift control. The Engine emergency stop switch incorporates a shut-off switch, switch clip, lanyard and lanyard clip, which is clipped to the operator when running.

If an emergency arises and the engine must be shut down, a pull on the cord to release the clip from the shut-off will shut off the engine.

This switch is designed to shut the engine off when the operator of the boat leaves the control station, either accidentally by falling into the boat, or by being ejected overboard. This would most likely occur as a result of poor operating practices.

Emergency Engine Stop Switch

Fig. 1.16.1

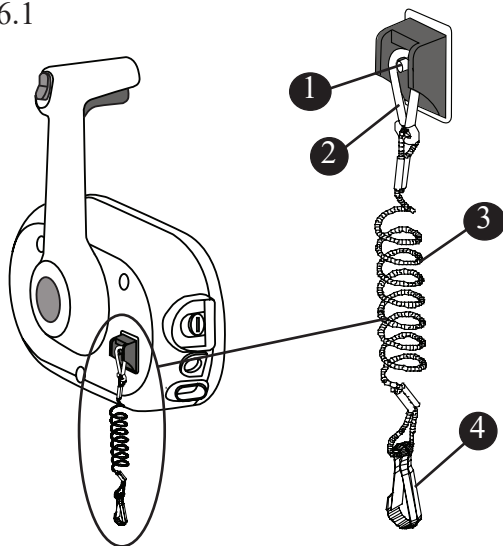

- ① ENGINE EMERGENCY STOP SWITCH
- ② ENGINE EMERGENCY STOP SWITCH CLIP, (ATTACHED TO SWITCH)
- ③ LANYARD
- ④ ENGINE EMERGENCY STOP SWITCH CLIP, (ATTACH TO OPERATOR)

The lanyard should be long enough to prevent inadvertent activation. Do not let the lanyard become entangled.

Accidental loss of power can be hazardous, particularly while docking or in heavy seas, strong current or high winds. Passengers and crew may lose balance and the boat may lose steering control.

Should the operator fall out of the boat at planing speed, it may take several seconds for the engine and propeller to stop turning. The boat may continue to coast for several hundred feet, causing injury to anyone in its path.

Float Plan

Float plans are important to you should you encounter problems on the water. A float plan should contain a description of your boat along with any distinguishing features. It should describe where you will be boating, your departure time and estimated return. The number and names of passengers, and destination should also be noted.

The float plan should be given to a friend or relative, so they can give the information to a national boating agency like the U.S. Coast Guard, in the event you do not return at the time specified on the float plan.

If there are any changes to the float plan they should be conveyed to the person holding the float plan. Once you return you should contact the person holding the float plan to let them know you are back.

Chart Your Course

To avoid boating in unsafe areas where there are underwater obstructions, shallow water, unnavigable conditions such as dangerous currents, and others, you must chart a course. This means having and using National Oceanic and Atmospheric Administration (NOAA) charts for coastal waters, observing and understanding all navigational aids, using the knowledge and guidance of experienced boaters, and being aware of the tides and times where appropriate. If you are boating in an area you are unfamiliar with, proceed with caution and post a lookout to watch for hazards.

WARNING

Hitting an object in or under the water or boating in dangerous currents can cause serious injury or death to occupants in the boat.

You must know where the hazards are and avoid them. In uncharted waters, boat very slowly and post a lookout.

If an object is struck or if you run aground:

- **Shut the engine OFF**
- **Check the hull for damage**
- **Check the propeller(s) for damage**
- **If aground, consider the bottom grade before moving off, (damage to the hull and propeller(s) could be worsened).**
- **Determine the tides and whether it will help or hinder you from the grounding.**
- **Do not have anyone other than a trained and competent service tow your boat.**

Environmental Considerations

Fuel & Oil Spillage

Regulations prohibit discharging fuel or oily waste in navigable waters. Discharge is defined as any action which causes a film, sheen or discoloration on the water surface, or causes a sludge or emulsion beneath the water surface. A common violation is

bilge discharge. Use rags or sponges to soak up fuel or oily waste, then dispose of it properly ashore. If there is much fuel or oil in the bilge, contact a knowledgeable marine service to remove it. Never pump contaminated bilge overboard. Help protect your waters.

Excessive Noise

Many areas regulate noise limits. Even if there are no laws, courtesy demands that boats operate quietly.

Wake / Wash

Power boat wakes can endanger people and vessels. Each power boat operator is responsible for injury or damage caused by the boat's wake. Be especially careful in confined areas such as channels or marinas. Observe "no wake" warnings.

WARNING

SPEED HAZARD - Watch your wake. It might capsize a smaller craft. You are responsible for damage caused by your wake.

WARNING

Reduce speed in congested waterway. Be alert for No Wake markers.

Homeland Security restrictions

Recreational boaters have a role in keeping our waterways safe and secure. Violators of the restrictions below can expect a quick and severe response.

- **DO NOT** approach within 100 yards, and slow to minimum speed within 500 yards of any U.S. Naval vessel. If you need to pass within 100 yards of a U.S. Naval vessel for safe passage, you must contact the U.S. Naval vessel or the Coast Guard escort vessel on VHF-FM channel 16.
- Observe and avoid all security zones. Avoid commercial port areas, especially those that involve military, cruise line or petroleum facilities. Observe and avoid other restricted areas near dams, power plants, etc.
- **DO NOT** stop or anchor beneath bridges or in channels.

DANGER

DO NOT approach within 100 yards of any U.S. Naval vessel without first contacting the vessel on VHF-FM channel 16. To do so will result in a quick and severe response.

America's Waterway Watch

In March, 2005, the U.S. Coast Guard officially launched *America's Waterway Watch* to encourage the boating public to report suspicious activities in our nation's ports and waterways. *America's Waterway Watch* simply asks anyone who works, lives, or recreates on the water to keep an eye out for suspicious activities. Anyone who spots such activity is asked to call the National Response Center's 24-hour hotline, 800-424-8802 or 877-24WATCH (877-249-2824).

Warning Label Locations

Mounted at key locations throughout the boat (See figure 1.19.1), warning labels advise the owner/operator of imperative safety precautions to follow when operating and/or servicing equipment. **DO NOT REMOVE OR OBSTRUCT ANY WARNING LABEL.** Replace any label which becomes illegible.

Warning Label Locations

Warning Label Locations
Fig.1.19.1

Proposition 65

1  **WARNING**

A WIDE VARIETY OF COMPONENTS USED ON THIS VESSEL CONTAIN OR EMIT CHEMICALS KNOWN TO THE STATE OF CALIFORNIA TO CAUSE CANCER AND BIRTH DEFECTS AND OTHER REPRODUCTIVE HARM.

EXAMPLES INCLUDE:

- ENGINE AND GENERATOR EXHAUST
- ENGINE AND GENERATOR FUEL, AND OTHER LIQUIDS SUCH AS COOLANTS AND OIL, ESPECIALLY USED MOTOR OIL
- COOKING FUELS
- CLEANERS, PAINTS, AND SUBSTANCES USED FOR VESSEL REPAIR
- WASTE MATERIALS THAT RESULT FROM WEAR OF VESSEL COMPONENTS
- LEAD FROM BATTERY TERMINALS AND FROM OTHER SOURCES SUCH AS BALLAST OR FISHING SINKERS

TO AVOID HARM:

- KEEP AWAY FROM ENGINE, GENERATOR, AND COOKING FUEL EXHAUST FUMES
- WASH AREAS THOROUGHLY WITH SOAP AND WATER AFTER HANDLING THE SUBSTANCES ABOVE

CALIFORNIA RESIDENTS ONLY
THIS WARNING IS ATTACHED TO THE STEERING WHEEL PRIOR TO DELIVERY OF ANY BOATS SOLD IN THE STATE OF CALIFORNIA IN ACCORDANCE WITH CALIFORNIA HEALTH & SAFETY CODE 25249.5-.13



2 

LOOK BEFORE YOU PUMP!

USE E10 FUEL

Do not use any fuel containing greater than 10 percent ethanol (E10) in this equipment. It may cause damage or failure and is prohibited by federal law. For more information, www.LookBeforeYouPump.com

Ethanol Percentage

<10%  15% - 30% - 85% 

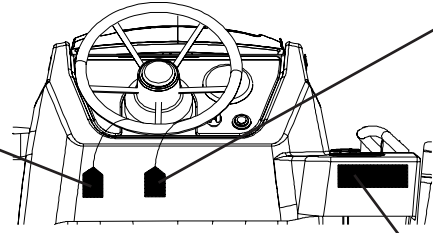

3  **WARNING**

Carbon monoxide (CO) can cause brain damage or death.

Engine and generator exhaust contains odorless and colorless carbon monoxide gas.

Signs of carbon monoxide poisoning include nausea, headache, dizziness, drowsiness, and lack of consciousness.

Get fresh air if anyone shows signs of carbon monoxide poisoning.

See Owner's Manual for information regarding carbon monoxide poisoning.

NW-264-05

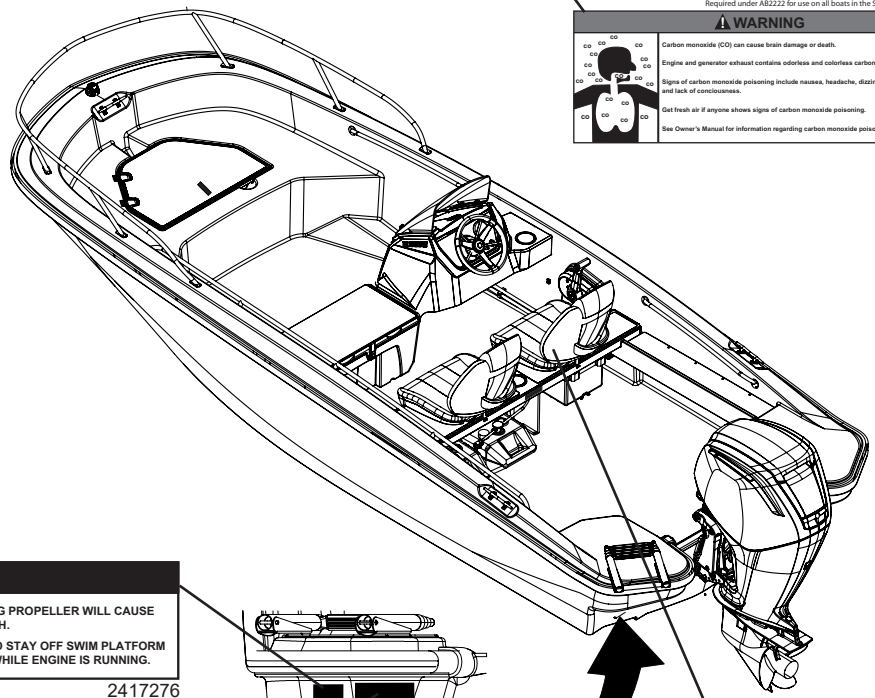

5  **DANGER**



CONTACT WITH A SPINNING PROPELLER WILL CAUSE SERIOUS INJURY OR DEATH.

STAY CLEAR OF BOAT AND STAY OFF SWIM PLATFORM AND BOARDING LADDER WHILE ENGINE IS RUNNING.

2417276

6  **DANGER**



Carbon monoxide (CO) can cause brain damage or death.

Engine and generator exhaust contains odorless and colorless carbon monoxide gas.

Carbon monoxide will be around the back of the boat when engines or generators are running.

Move to fresh air if you feel nausea, headache, dizziness or drowsiness.

NW-206-05

Required under AB2222 for use on all boats in the State of California

4  **WARNING**

AVOID SERIOUS INJURY OR DEATH
UNSECURED SEAT MAY STRIKE OCCUPANT OR CAUSE LOSS OF BOAT CONTROL.
SECURE SEAT WITH LATCH.

MRP# 1971919

Replacement Part No.

| | | |
|----------|----------------------------|---------|
| 1 | PROP 65 HANG TAG..... | 1795087 |
| 2 | ETHANOL E10 WARNING | 2304853 |
| 3 | WARNING CO HELM | 1811368 |
| 4 | WARNING, SECURE SEAT | 1971919 |
| 5 | DANGER, PROP DANGER..... | 2417276 |
| 6 | DANGER CO TRANSOM..... | 1811367 |

NOTICE

It is important to replace any damaged or unreadable label. Call your Boston Whaler dealer for replacement labels.

Warning Label Locations (Cont'd)

Warning Label Locations

Fig.1.20.1

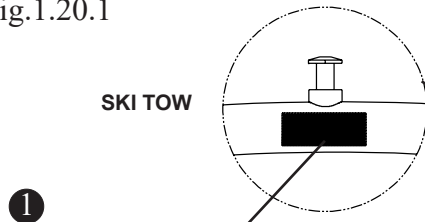
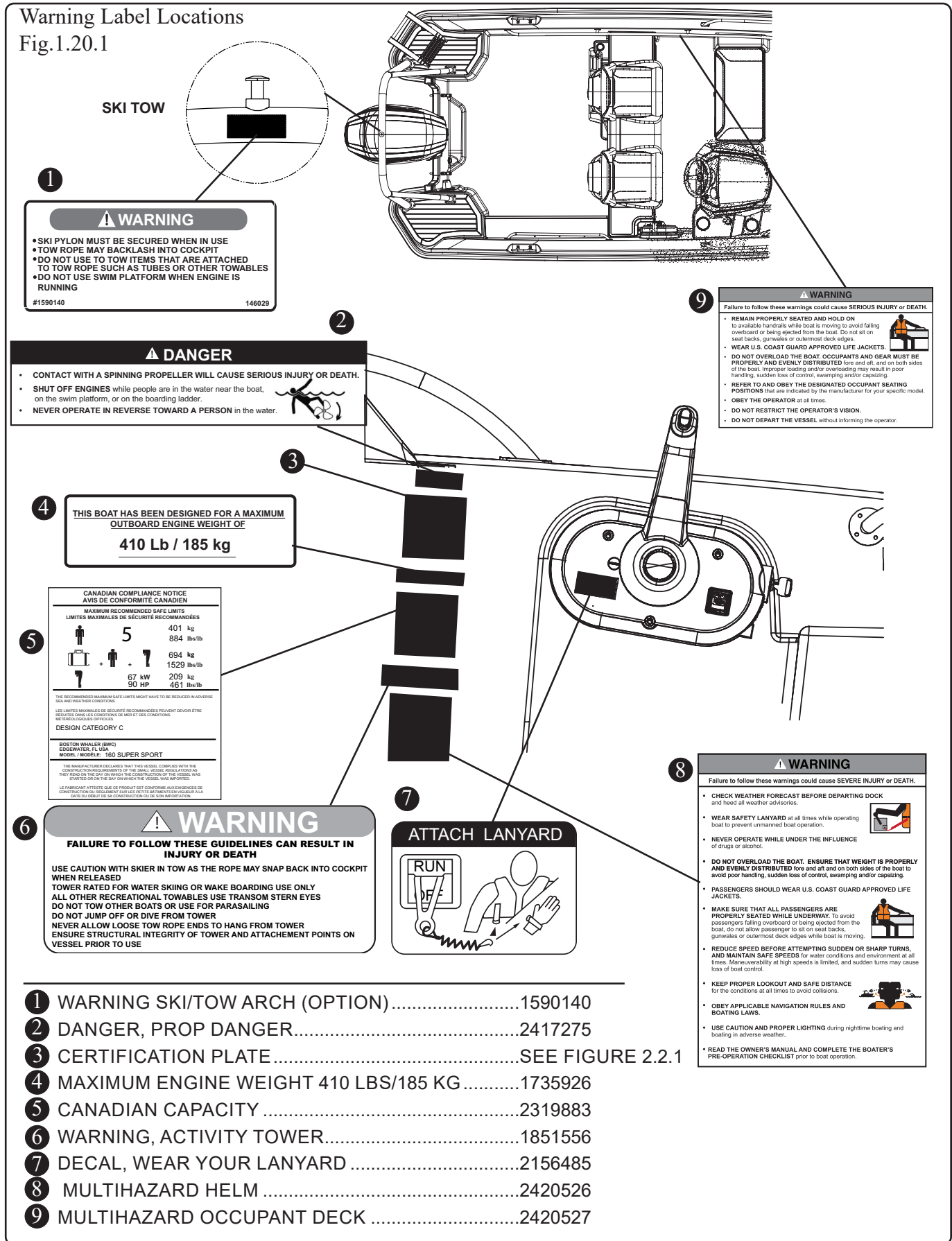

1

⚠ WARNING

- SKI PYLON MUST BE SECURED WHEN IN USE
- TOW ROPE MAY BACKLASH INTO COCKPIT
- DO NOT USE TO TOW ITEMS THAT ARE ATTACHED TO TOW ROPE SUCH AS TUBES OR OTHER TOWABLES
- DO NOT USE SWIM PLATFORM WHEN ENGINE IS RUNNING

#1590140 246029

2

⚠ DANGER

- CONTACT WITH A SPINNING PROPELLER WILL CAUSE SERIOUS INJURY OR DEATH.
- SHUT OFF ENGINES while people are in the water near the boat, on the swim platform, or on the boarding ladder.
- NEVER OPERATE IN REVERSE TOWARD A PERSON in the water.

9

⚠ WARNING

Failure to follow these warnings could cause SERIOUS INJURY or DEATH.

- REMAIN PROPERLY SEATED AND HOLD ON to available handrails while boat is moving to avoid falling overboard or being ejected from the boat. Do not sit on seat backs, gunwales or outermost deck edges.
- WEAR U.S. COAST GUARD APPROVED LIFE JACKETS.
- DO NOT OVERLOAD THE BOAT. OCCUPANTS AND GEAR MUST BE PROPERLY AND EVENLY DISTRIBUTED fore and aft, and on both sides of the boat. Improper loading and/or overloading may result in poor handling, sudden loss of control, swamping and/or capsizing.
- REFER TO AND OBEY THE DESIGNATED OCCUPANT SEATING POSITIONS that are indicated by the manufacturer for your specific model.
- OBEY THE OPERATOR at all times.
- DO NOT RESTRICT THE OPERATOR'S VISION.
- DO NOT DEPART THE VESSEL without informing the operator.

4

THIS BOAT HAS BEEN DESIGNED FOR A MAXIMUM OUTBOARD ENGINE WEIGHT OF

410 Lb / 185 kg

5

CANADIAN COMPLIANCE NOTICE
AVIS DE CONFORMITÉ CANADIEN

MAXIMUM RECOMMENDED SAFE LIMITS
LIMITES MAXIMALES DE SÉCURITÉ RECOMMANDÉES

| | | |
|--|----------|-----------------------|
| | 5 | 401 kg 884 lbs/lb |
| | 7 | 694 kg 1529 lbs/lb |
| | 7 | 67 kW 90 HP |

THE RECOMMENDED MAXIMUM SAFE LIMITS MIGHT VARY TO BE REDUCED IN ADVERSE SEA AND WEATHER CONDITIONS.

LES LIMITES MAXIMALES DE SÉCURITÉ RECOMMANDÉES PEUVENT ÊTRE RÉDUITES DANS LES CONDITIONS DE MER ET DES CONDITIONS.

DESIGN CATEGORY C

BOSTON WHALER (BWC)
ESTABLISHED, FL USA
MODEL / MODÈLE: 160 SUPER SPORT

LE FABRICANT DÉCLARE QUE CE PRODUIT EST CONFORME AUX EXIGENCES DE CONSTRUCTION DE PRODUIT EN MATIÈRE DE SÉCURITÉ EN VIGILANCE ALA DATE DU DÉBUT DE SA CONSTRUCTION OU DE SON IMPORTATION.

6

⚠ WARNING

FAILURE TO FOLLOW THESE GUIDELINES CAN RESULT IN INJURY OR DEATH

USE CAUTION WITH SKIER IN TOW AS THE ROPE MAY SNAP BACK INTO COCKPIT WHEN RELEASED

TOWER RATED FOR WATER SKIING OR WAKE BOARDING USE ONLY

ALL OTHER RECREATIONAL TOWABLES USE TRANSOM STERN EYES

DO NOT TOW OTHER BOATS OR USE FOR PARASAILING

DO NOT JUMP OFF OR DIVE FROM TOWER

NEVER ALLOW LOOSE TOW ROPE ENDS TO HANG FROM TOWER

ENSURE STRUCTURAL INTEGRITY OF TOWER AND ATTACHEMENT POINTS ON VESSEL PRIOR TO USE

7

ATTACH LANYARD

8

⚠ WARNING

Failure to follow these warnings could cause SEVERE INJURY or DEATH.

- CHECK WEATHER FORECAST BEFORE DEPARTING DOCK and heed all weather advisories.
- WEAR SAFETY LANYARD at all times while operating boat to prevent unmanned boat operation.
- NEVER OPERATE WHILE UNDER THE INFLUENCE of drugs or alcohol.
- DO NOT OVERLOAD THE BOAT. ENSURE THAT WEIGHT IS PROPERLY AND EVENLY DISTRIBUTED fore and aft and on both sides of the boat to avoid poor handling, sudden loss of control, swamping and/or capsizing.
- PASSENGERS SHOULD WEAR U.S. COAST GUARD APPROVED LIFE JACKETS.
- MAKE SURE THAT ALL PASSENGERS ARE PROPERLY SEATED WHILE UNDERWAY. To avoid passengers falling overboard or being ejected from the boat, do not allow passenger to sit on seat backs, gunwales or outermost deck edges while boat is moving.
- REDUCE SPEED BEFORE ATTEMPTING SUDDEN OR SHARP TURNS, AND MAINTAIN SAFE SPEEDS for water conditions and environment at all times. Maneuverability at high speeds is limited, and sudden turns may cause loss of boat control.
- KEEP PROPER LOOKOUT AND SAFE DISTANCE for the conditions at all times to avoid collisions.
- OBEY APPLICABLE NAVIGATION RULES AND BOATING LAWS.
- USE CAUTION AND PROPER LIGHTING during nighttime boating and boating in adverse weather.
- READ THE OWNER'S MANUAL AND COMPLETE THE BOATER'S PRE-OPERATION CHECKLIST prior to boat operation.

| | | |
|----------|--|------------------|
| 1 | WARNING SKI/TOW ARCH (OPTION) | 1590140 |
| 2 | DANGER, PROP DANGER | 2417275 |
| 3 | CERTIFICATION PLATE | SEE FIGURE 2.2.1 |
| 4 | MAXIMUM ENGINE WEIGHT 410 LBS/185 KG | 1735926 |
| 5 | CANADIAN CAPACITY | 2319883 |
| 6 | WARNING, ACTIVITY TOWER | 1851556 |
| 7 | DECAL, WEAR YOUR LANYARD | 2156485 |
| 8 | MULTIHAZARD HELM | 2420526 |
| 9 | MULTIHAZARD OCCUPANT DECK | 2420527 |

Section 1 • Safety

Key to Symbols on Controls & Prints

Although not used in this manual, some of these symbols may be found on the controls, gauges, and hardware on your boat. This page is to help you understand what the symbols mean.

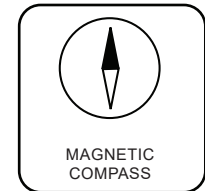
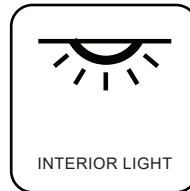
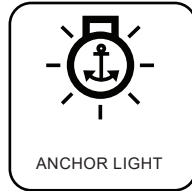
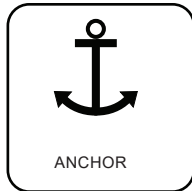
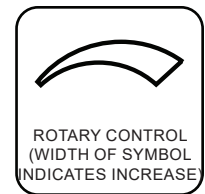
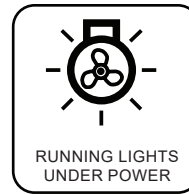
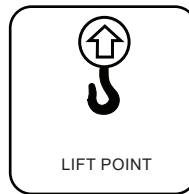
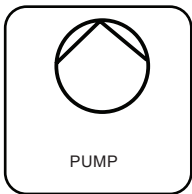
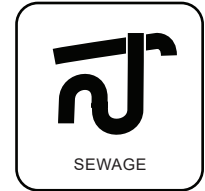
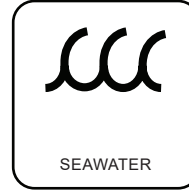
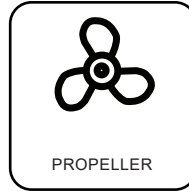
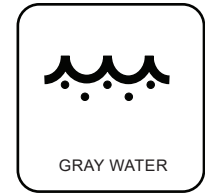
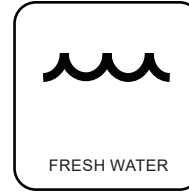
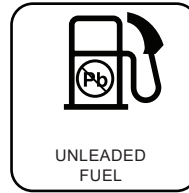
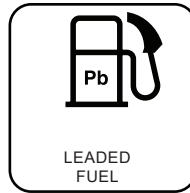
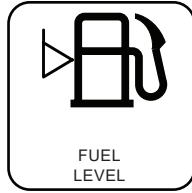
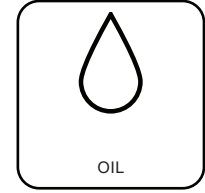
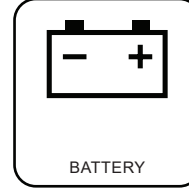
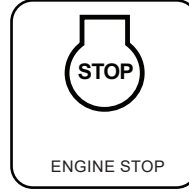
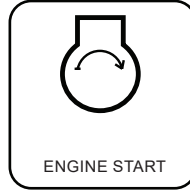
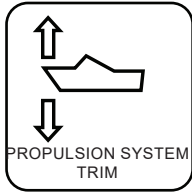

THIS PAGE INTENTIONALLY LEFT BLANK

Construction Standards

Boston Whaler® is dedicated to creating a superior product which will provide comfort, performance, safety and dependability. All of our boats comply with the safety standards set by the United States Coast Guard and are designed, engineered and manufactured in accordance with applicable recommendations and guidelines of the American Boat and Yacht Council (A.B.Y.C.) and certified by the National Marine Manufacturers Association (N.M.M.A.).

Our Hull

Boston Whaler® hulls are constructed with our patented Unibond™ construction process. This involves foam injection into a closed mold system where the foam expands to fill all voids in the hull. When the finished product is pulled from the mold, the hull and deck are chemically bonded to form a solid, inseparable unit.

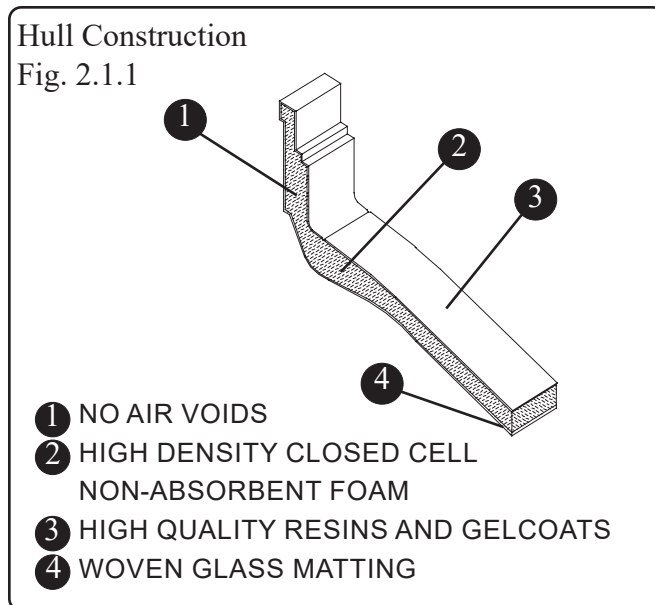

Hull Identification Number

The “Hull Identification Number” is located on the starboard side of the transom.

This is the most important identifying factor and must be included in all correspondence related to your vessel. Also of vital importance are the engine serial numbers, part numbers, etc. when writing about or ordering parts for your engine.

Hull Identification Number (HIN)

Fig. 2.1.2

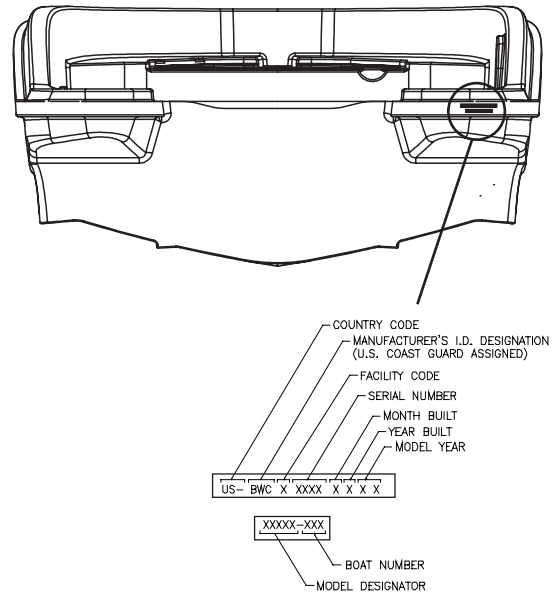

Record your HIN here:

Servicing Your Boston Whaler

When your Whaler requires service or maintenance work, it should be taken to an authorized Boston Whaler® dealer.

To find a Boston Whaler® dealer in your area call:
1-800-942-5379 (Domestic/International).

In the unlikely event that a problem is not handled to your satisfaction, discuss any warranty related problems directly with the service manager of the dealership or your sales person. Give the dealership an opportunity to help the service department resolve the matter for you.

Manufacturer's Certification

All boats must comply with federal regulations regarding maximum capacities. The certification plate (See figure 2.2.1) located on control console indicates the maximum weight, number of persons, and horsepower your boat is rated to handle.

Section 2 • General Information

⚠ DANGER

NEVER carry more weight or passengers than indicated on the certification plate, regardless of the weather or water conditions.

The number of persons on board must be reduced if you go out in poor weather and rough water.

The information present on the certification plate does not relieve the operator from responsibility. Use common sense and sound judgement when placing equipment and/or passengers in your boat.

- Do not load to capacity in poor weather or rough water.
- The number of seats does not indicate how many people a boat can carry, especially in poor weather and rough water.
- Above idle speed, all passengers must be seated on the seats provided.

NMMA Certification means that your Boston Whaler® has been judged by the National Marine Manufacturers Association to be in compliance with applicable federal regulations and American Boat and Yacht Council standards.

A **Canada Conformity Sticker** means that your Boston Whaler® has been certified to comply with construction standards for small vessels by Transport Canada.

A **CE mark** means that your Boston Whaler® has been certified with applicable International Organization for Standardization directives.

An **Australian Builder's plate** means that your Boston Whaler® has been certified to comply with safety standards set by the National Marine Safety Committee.

Certification Plates

Fig. 2.2.1



Replacement Part No. 2319875

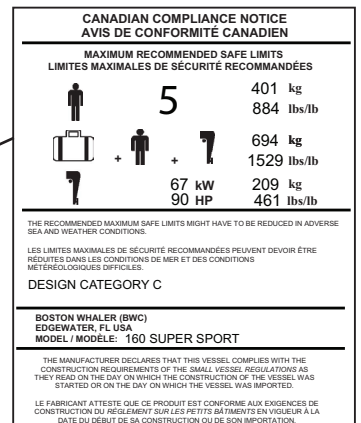

Replacement Part No. 2319883

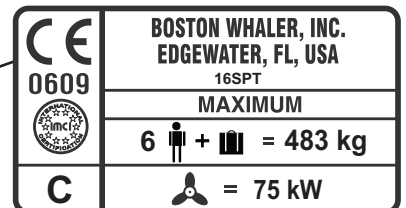

Replacement Part No. 2399381



Replacement Part No. 2410420

- 1 NMMA CERTIFICATE
- 2 CANADA CONFORMITY STICKER
- 3 CE MARK (INT'L) BUILDER'S PLATE
- 4 AUSTRALIAN BUILDER'S PLATE

Section 2 • General Information

Certification Design Category

A: A recreational craft given design category A is considered to be designed for winds that may exceed wind force 8 (Beaufort scale) and significant wave heights of 4 meters and above but excluding abnormal conditions, such as storm, violent storm, hurricane, tornado and extreme sea conditions or rogue waves.

B: A recreational craft given design category B is considered to be designed for a wind force up to, and including, 8 and significant wave heights up to, and including 4 m.

C: A watercraft given design category C is considered to be designed a wind force up to, and including 6 and significant wave heights up to, and including, 2 m.

D: A watercraft given design category D is considered to be designed for a wind force up to, and including 4 and significant wave heights up to, and including, 0,3 m, with occasional waves of 0,5 m maximum height.

The significant wave height is considered to be the primary factor for determining design category. Other parameters (e.g. meteorological) are descriptions of when these wave heights may be expected to occur. Refer to page 1-11 for weather information.

NOTICE

Your 160 Super Sport is design category C

WARNING

It is imperative that you follow the recommendations listed on your capacity plate regarding the maximum amount of weight the boat can safely carry.

Power Capacity

The certification plate, as well as “Specifications & Dimensions” on the following page has the maximum rated power listed for your boat. **DO NOT EXCEED THIS RATING.** The various engine types offered today are more powerful and require constant maintenance to stay at optimal performance. It is required of the owner/operator to read all information regarding safety features, warning notices and maintenance schedules for continued safe operation of the engine.

The engine on the 160 Super Sport has been tested and proven to be best suited for general use under normal conditions and load.

If you are re-powering your Boston Whaler®, you should pay particular attention to the maximum/minimum horsepower and maximum safe engine weight load your Boston Whaler® boat is rated for.

The 160 Super Sport is designed for a maximum outboard engine weight of 410 LBS (185 kg).

WARNING

- **DO NOT Exceed the maximum engine power rating stated on the certification plate.**
- **Use caution while accelerating. Make sure passengers are safely seated in designated areas of the boat and all gear is stowed securely.**

NOTICE

Always adjust the speed and direction of the craft to the varying sea conditions.

Section 2 • General Information

Dimensions & Clearances

Fig. 2.4.1

NOTE: Sun top shown for reference only.

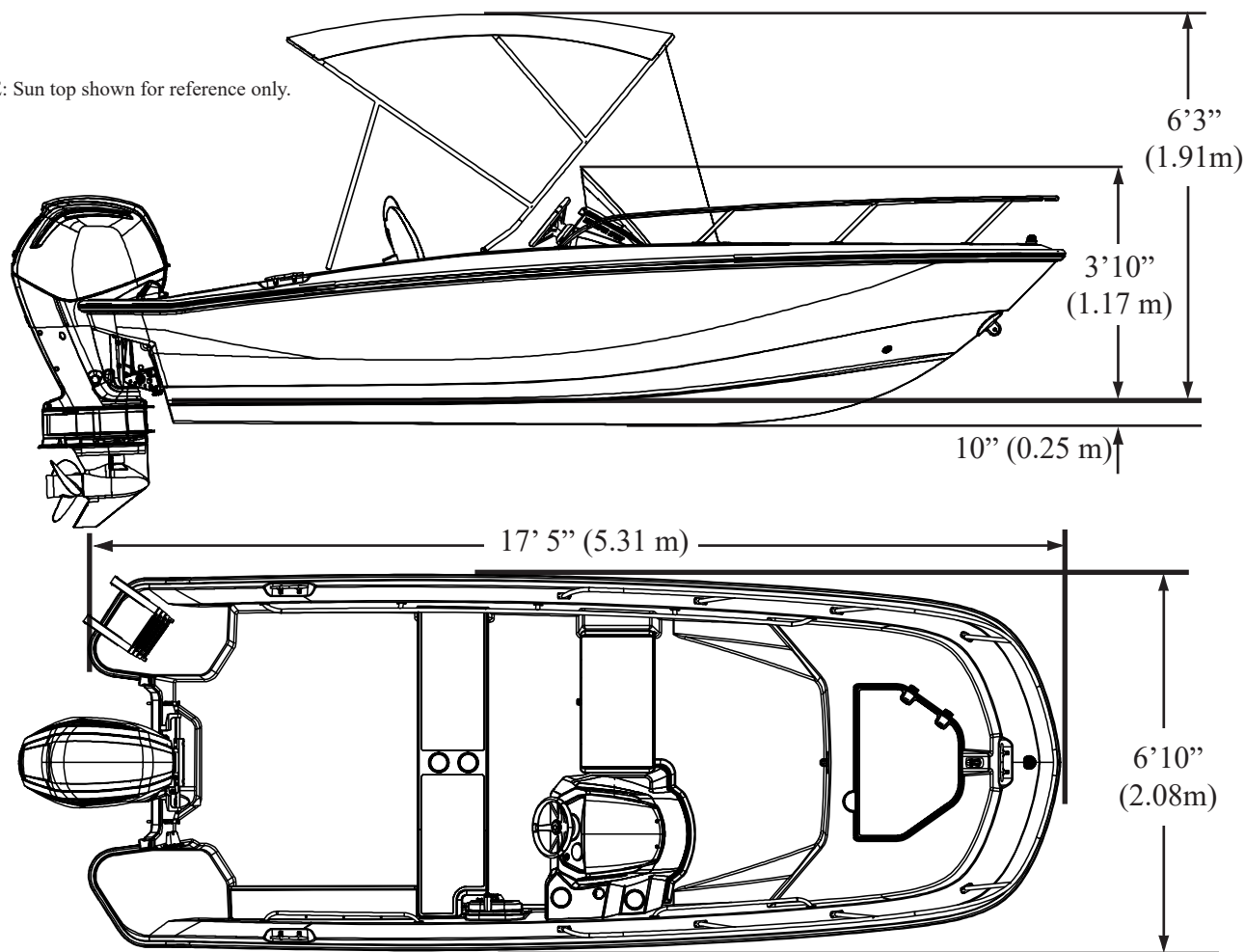

Specifications & Dimensions

(Specified measurements are approximations and are subject to variance.)

| | | | | | |
|---------------------------------|------------|---------|--|-----------|----------|
| Overall Length | 17'5" | 5.31 m | Maximum Engine Weight | 410 lbs. | 185 kg |
| Bridge Clearance (no top) | 3' 10" | 1.17 m | Maximum Weight, | 1,529 lbs | 694 kg |
| Bridge Clearance (Sun- Top) | 6'3" | 1.91 m | (passengers, engine(s), gear) ³ | | |
| Boat on Trailer ¹ | 7' 5" | 2.26 m | Persons | 6 | |
| Beam | 6'10" | 2.08 m | Maximum Horsepower | 90 HP | 67.11 kw |
| Draft, (Hull only) ² | 10" | .25 m | Minimum Horsepower | 75 HP | 56 kw |
| Weight (dry, no engine) | 1,060 lbs. | 480 kg | Fuel Capacity | 13 gal. | 49.2 L |
| Swamped Capacity | 3,000 lbs | 1360 kg | Fuel Capacity (Option) | 19 gal. | 71.9 L |

¹ With engine down. This is an approximate measurement. The true height of your boat on your trailer is dependent on a number of variables (i.e. bunk adjustment, bunk padding, tire pressure, etc.)

² Optional equipment and loading of the boat will affect the draft measurements. Follow the recommendations list on your capacity plate regarding the maximum amount of weight your boat can safely carry.

³ Exceeding this weight will affect the boat's performance. **DO NOT** Exceed the weights listed on the capacity plate.

Passenger Areas

Deck Occupancy
Fig. 2.5.1

Working deck



This area is intended for occupation **ONLY** while mooring, anchoring, loading/unloading or when the boat is at rest. **NEVER** operate the engine while loading or unloading swimmers/divers from the swim platform/ladder.

Accommodation deck



This area of the boat is inside the cockpit and includes helm seating. Movement in this area should be done with extreme caution while the boat is underway. A sudden shift in boat direction can cause a loss of balance and lead to injury or death.

DANGER

Be aware of your footing while the boat is underway, slipping or falling could result in serious injury or death, especially if the boat is in motion or in rough seas. Keep the accommodation deck clean, so if movement is necessary it will be free of obstruction.

WARNING

- Gelcoat surfaces are slippery when wet. Use extreme caution when walking on wet surfaces.
- Never occupy the working decks while the boat is underway.
- Use care when waxing to ensure that walkways are not made dangerously slippery.

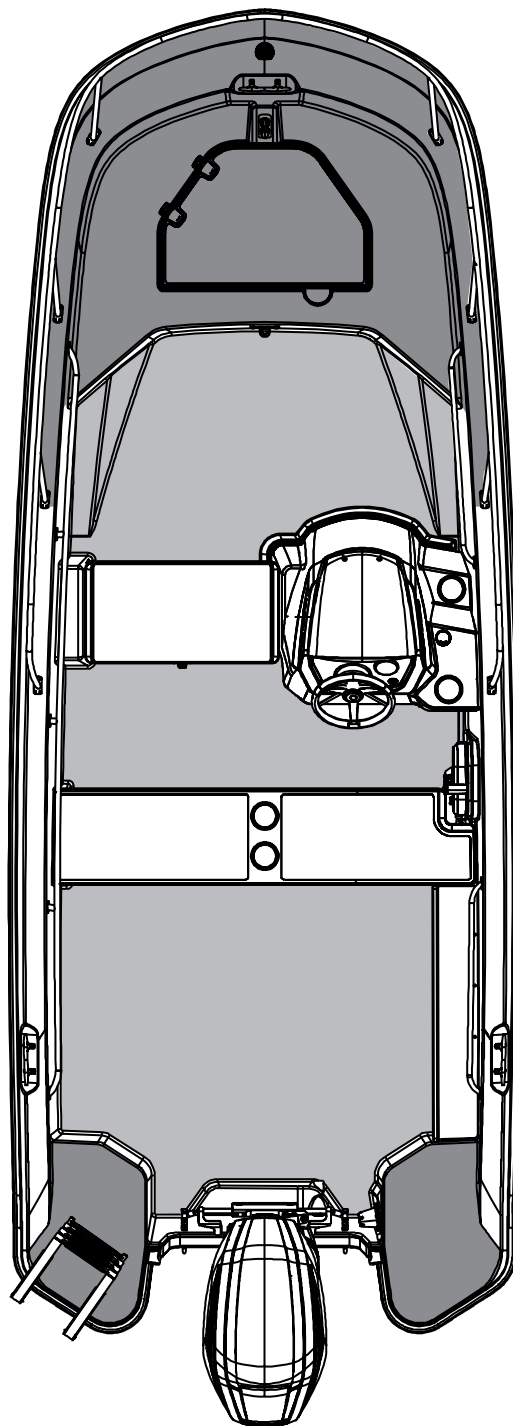

Recommended Passenger Locations

Recommended Passenger Locations

Fig. 2.6.1

! WARNING
NEVER allow passengers to ride in an area (i.e. bow, gunnels, transom, etc.) that will pose a hazard to themselves or the boat.

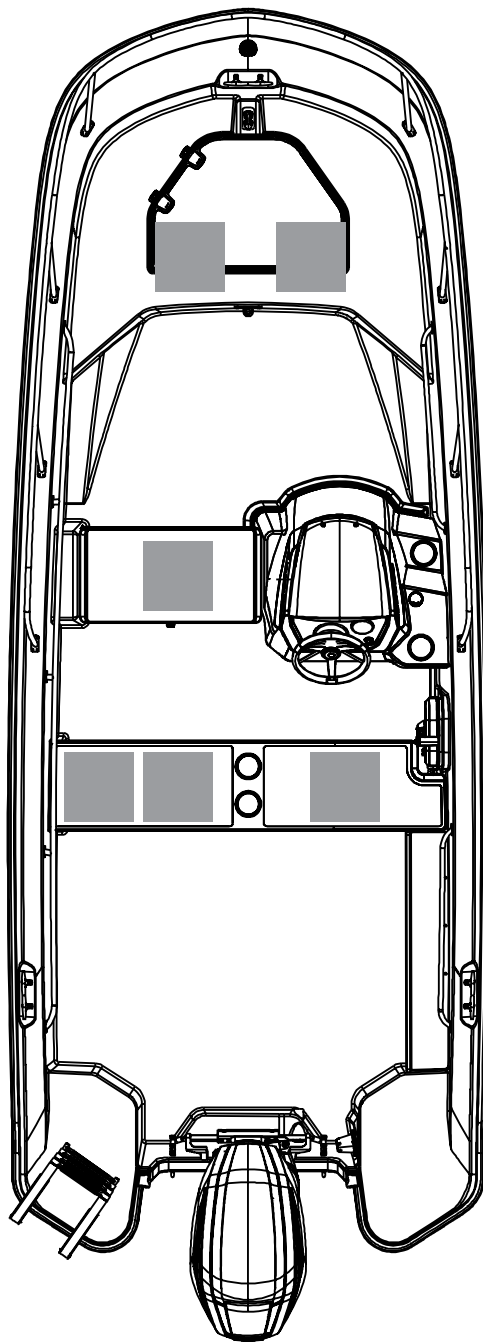

Location of Thru-Hull Fittings

Through Hull Fittings
Fig. 2.7.1

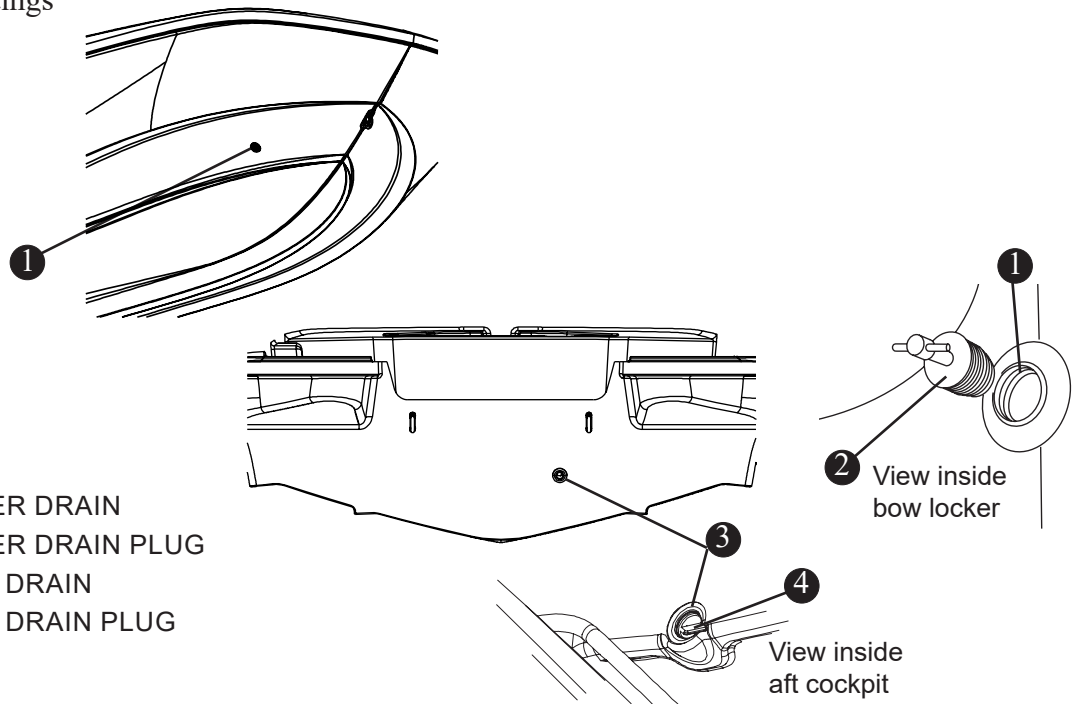

NOTICE

- **The bow locker and cockpit drain plugs must be in place when moored, underway or occupied.**
- Depending on the type of boat you have, you may have underwater fittings. Any fitting that will be underwater needs to be plugged or the seacock needs to be closed.
- Through hull fittings and deck drain scupper flaps should be checked for proper seal annually. When the boat is in the water the underwater fittings can be checked for dripping. It is recommended that the underwater fittings be removed, cleaned and resealed every other year.
- If the through hull fittings need to be replaced, it is recommended that an authorized Boston Whaler® dealer perform this type of repair. Through hull fittings that are improperly installed can cause premature hull failure and may void the Boston Whaler® limited warranty.
- A standard 1" "Snap-Tite" style plug can be used to replace the drain plug(s) in your boat. It is recommended that you carry spare plugs to be used in the event that the drain plug(s) become lost or damaged.

Section 2 • General Information

Features

Features
Fig. 2.8.1

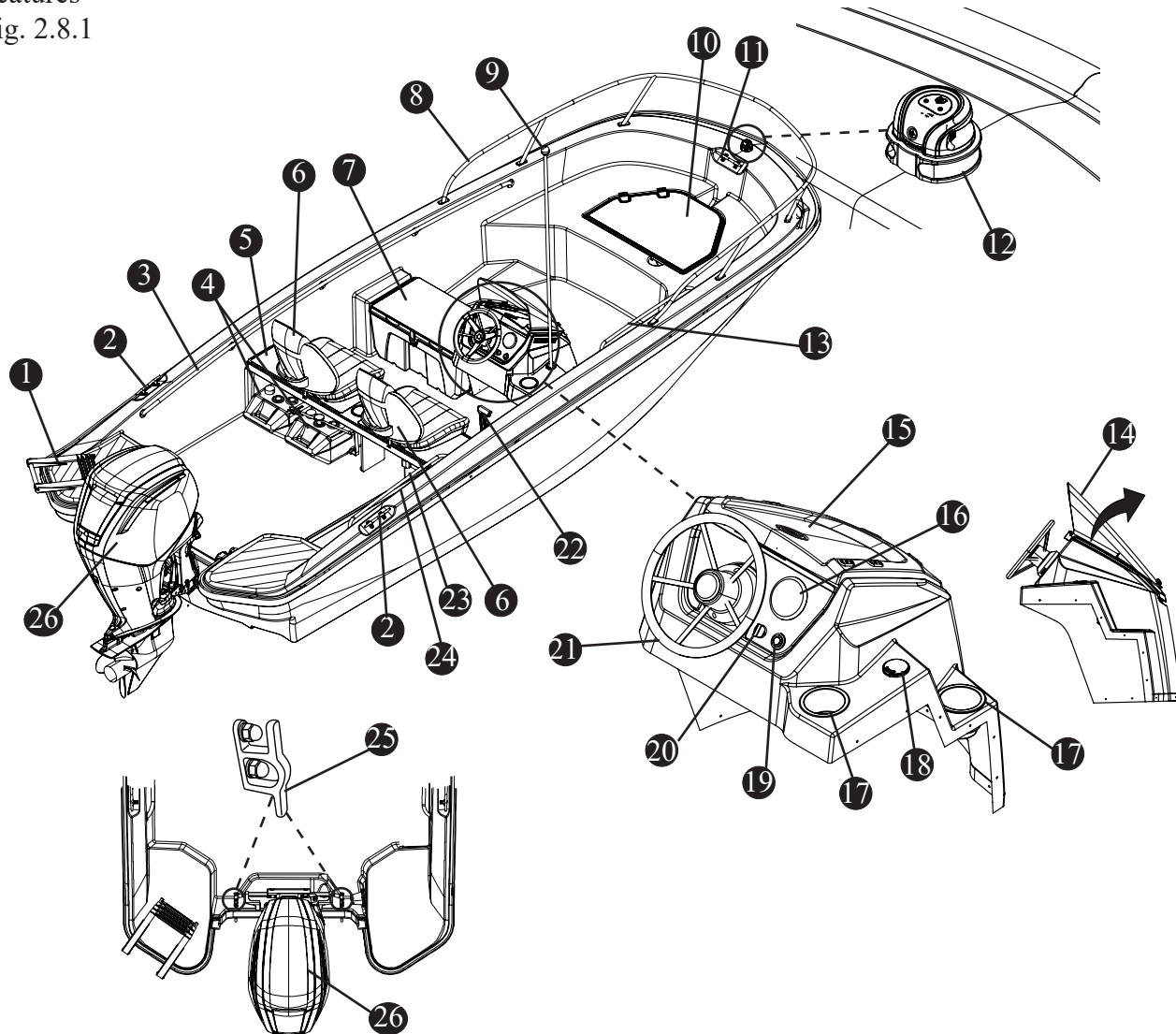

- | | |
|--|----------------------------------|
| ① SWIM LADDER | ⑭ ACRYLIC WINDSHIELD (OPTION) |
| ② STERN CLEAT (P&S) | ⑮ LOCKABLE STORAGE |
| ③ PORT STAINLESS STEEL SIDE RAIL | ⑯ TACHOMETER |
| ④ 6.5 GAL (24.6 L) PORTABLE FUEL TANKS W/HOLD-DOWN STRAP (2) | ⑰ CUPHOLDER |
| ⑤ HELM BENCH SEAT W/CUPHOLDERS | ⑱ ANCHOR LIGHT RECEPTACLE |
| ⑥ BUCKET SEAT W/BACKREST (OPTION) | ⑲ 12 VOLT RECEPTACLE |
| ⑦ COOLER SEAT | ⑳ NAV/ANCH SWITCH |
| ⑧ BOW RAIL (OPTION) | ㉑ STAINLESS STEEL STEERING WHEEL |
| ⑨ ALL AROUND (ANCHOR) LIGHT | ㉒ GEAR SHIFT/THROTTLE CONTROL |
| ⑩ BOW LOCKER W/OVERBOARD DRAIN | ㉓ BATTERY BOX W/HOLD DOWN STRAP |
| ⑪ BOW CLEAT | ㉔ AFT STAINLESS STEEL SIDE RAIL |
| ⑫ BOW NAV LIGHT W/ROPE GUIDE | ㉕ TRANSOM CLEAT (2) |
| ⑬ FORWARD STAINLESS STEEL SIDE RAIL | ㉖ FOUR STROKE MERCURY ENGINE |

Optional Features

Features (Options)
Fig. 2.9.1

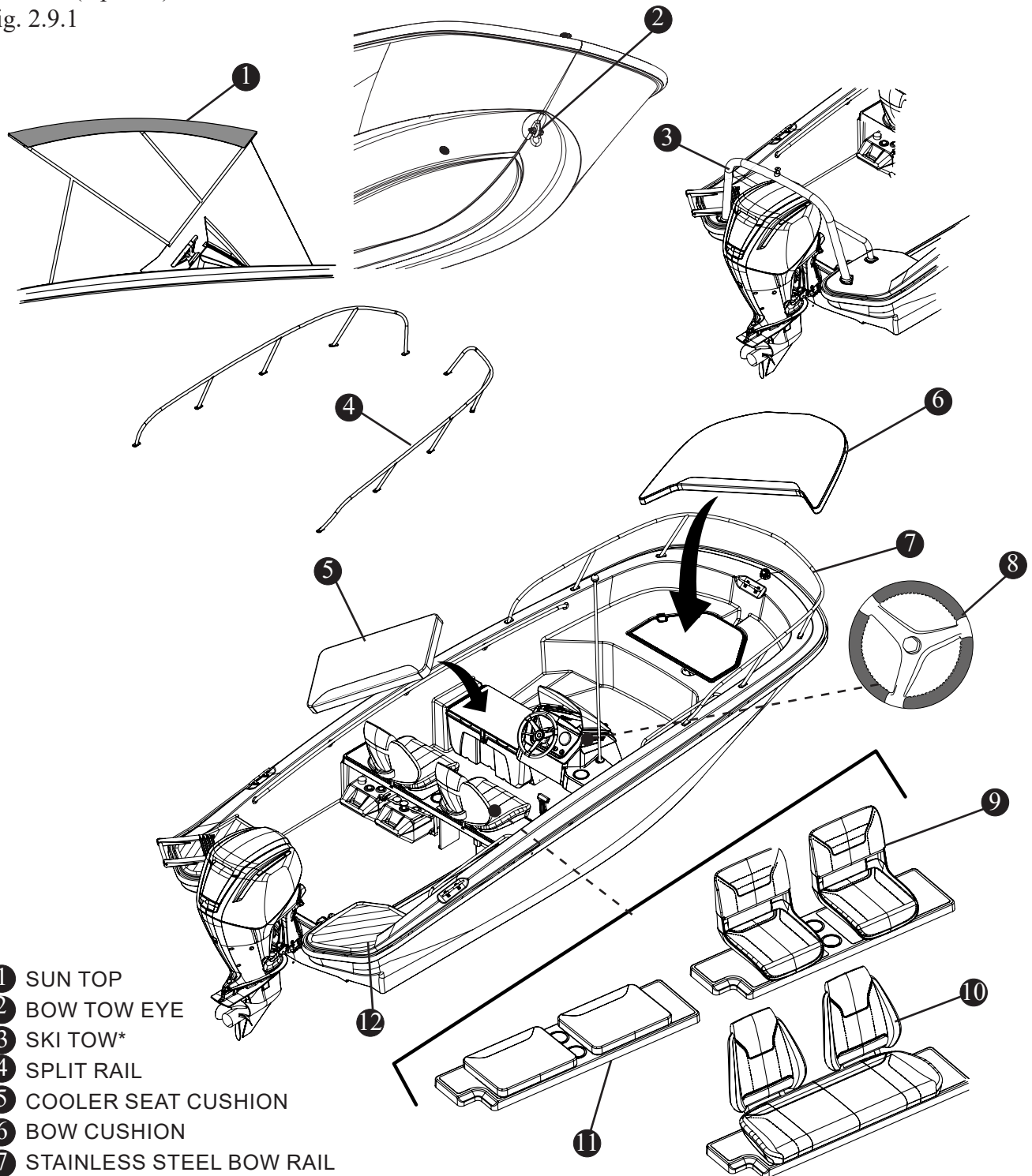

- ① SUN TOP
- ② BOW TOW EYE
- ③ SKI TOW*
- ④ SPLIT RAIL
- ⑤ COOLER SEAT CUSHION
- ⑥ BOW CUSHION
- ⑦ STAINLESS STEEL BOW RAIL
- ⑧ SPORT STEERING WHEEL
- ⑨ BUCKET SPORT SEAT (SINGLE OR PAIR)
- ⑩ BENCH SEAT W/BACKREST
- ⑪ BENCH SEAT CUSHIONS
- ⑫ SYNTHETIC TEAK BOARDING STEP

* Not compatible with 75 HP engine

NOTICE

All option installation instructions are available at www.bostonwhaler.com

Gear Shift & Throttle Control

! CAUTION

Shift controls into **NEUTRAL** before starting engine. Shift only when engine is at idle. Reversing at high speeds can cause flooding/swamping due to water being pushed over the transom.

NOTICE

Wind and sea currents can change how your boat responds while in motion. Understanding your boat and its reactions at speed will make boating for you safer and more enjoyable.

The 160 Super Sport is equipped with a gear shift/throttle control unit mounted starboard of the control console. The gear shift/throttle control unit for the engine activates both shifting mechanism and throttle.

The control must be in the “NEUTRAL” position to start your engine. Neutral is the most upright position of the control unit and acts as an idle, the propeller is not rotating. There is a “throttle only” button at the center of the throttle control that when depressed will disengage the shifting mechanism and will allow you to operate the throttle without engaging the propeller. This button will automatically engage the shifting mechanism once the throttle control has been moved back to its center position (you will hear and feel a click when it is engaged). Moving the lever forward engages the forward gear and then the throttle advance.

Gear shift/Throttle Control
Fig. 2.10.1

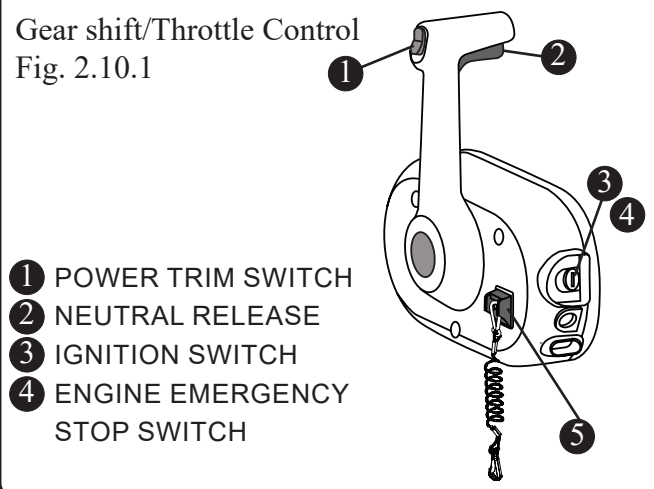

To reverse power, bring the control lever back to engage the reverse gear and increase the reverse thrust. The throttle control regulates the RPM of the engine. Regulating the RPM of the engine will control the speed of the boat.

! CAUTION

Reducing forward speed quickly, suddenly slowing the boat will create a following wake which may rise above the transom and flood the boat.

Understanding your boat and its reactions at speed will make boating for you safer and more enjoyable.

Power Trim Operation

NOTICE

Boats can be operated in a manner and speed resulting in trim angles that cause visibility to be obscured. Motor trim, hull trim plane and speed are factors that affect a boat's trim angle.

The power trim & tilt system allows you to raise and lower the engine outdrive for trailering, launching and beaching. This also allows for ideal boat angle (in relation to the water surface) for a given load and water condition. In most cases, best all-round performance is obtained with the engine adjusted so that the boat will run at a 3° to 5° angle to the water. The power trim is located on the inboard side of the gear shift/throttle lever handle.

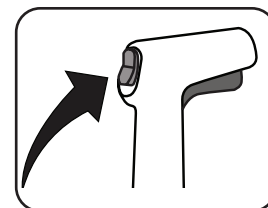

NOTICE

Boats can be operated in a manner and at certain speeds resulting in trim angles that could cause visibility to be obscured. Motor trim, hull trim plane angles (if equipped), boat load distribution and speed are factors that affect a boat's trim angle.

REFER TO THE ENGINE MANUFACTURER'S MANUAL IN YOUR OWNER'S MANUAL PACKET FOR COMPLETE INSTRUCTIONS, INFORMATION AND WARRANTY.

Navigation Lighting

This vessel comes equipped with navigation lighting for your safety. Regulations state that all boats must display navigation lights between sunset and sunrise and during periods of restricted visibility, such as rain, fog, haze, etc. If operating in reduced visibility or between sunset and sunrise it is necessary to maintain a safe speed and post a lookout.

It is the operator's responsibility to ensure that the navigation lights are in good working order and that the proper lighting is shown and not obstructed in its intended arc of visibility. Do not modify navigation lights. This vessel's navigation lights may include an expiration date on the housing. If one is located, replace light before expiration date, even if light is functional, as lighting quality may be compromised.

Do not add lights that interfere with required navigation lights. Some lights, such as blue colored lights, may be illegal to display on a boat. It is the owner's responsibility to ensure that displayed lights are also compliant with local regulations.

Navigation/Anchor Lighting
Fig. 2.11.1

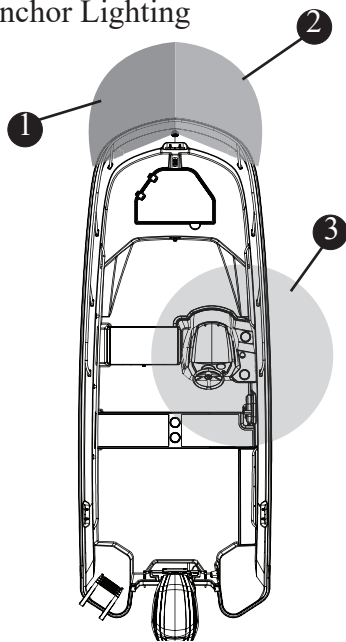

- 1 PORT NAVIGATION LIGHT (RED)
VISIBLE 2 NAUTICAL MILES
- 2 STARBOARD NAVIGATION LIGHT
(GREEN) VISIBLE 2 NAUTICAL MILES
- 3 360° ALL ROUND LIGHT (WHITE)
VISIBLE 2 NAUTICAL MILES

NOTICE

The improper sequence of navigation lighting may be as dangerous as no lighting at all.

Operating the Navigation Lighting

A three-position switch, located on the console (See below) controls the navigation and anchor lighting. In the "NAV" position the port (red), starboard (green) and 360° all around lights will illuminate. These lights let other vessels know the approximate size and direction of travel of your boat, depending on which lights they can see. In the "ANCH" position, the white, 360° light will illuminate, showing other boaters your location while at anchor.

When using the canvas sun-top with the console mounted anchor light be sure to slide the light through the opening in the top of the sun-top. Be sure to remove the light pole from the base before stowing the canvas Sun-top.

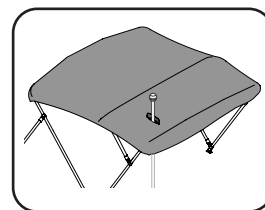

NOTICE

When using the optional SUN-TOP, make certain that all securing straps are taut. Damage to the navigation light can happen if the canvas frame straps are loose or not secured properly.

NAV/ANCH Switch Positions
Fig. 2.11.2

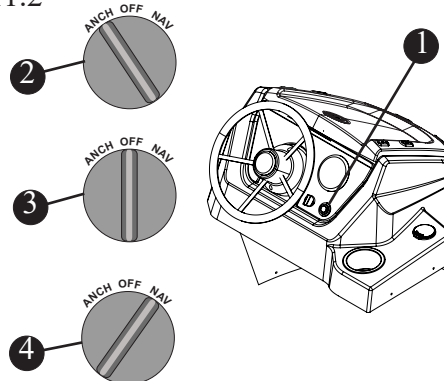

- 1 NAV/ANCH SWITCH
- 2 ANCHOR LIGHT "ON"
- 3 "OFF"
- 4 ANCHOR & BOW NAVIGATIONAL LIGHTS "ON"

Steering



Do not cover cracks in the steering cable or fittings with tape or other sealants. This will create a hazard in which the cable can fail without warning.

Your 160 Super Sport is equipped with a Teleflex no-feedback steering system. The Teleflex no-feedback steering system has a clutch mechanism which prevents the engine torque from being felt at the steering wheel. This reduces driver fatigue by eliminating the constant need to fight the wheel.

Maintenance:

The mechanical steering system should be checked periodically by your Boston Whaler® dealer for proper lubrication, alignment and to make sure there is no looseness or binding of the cable. Proper maintenance of this system will ensure worry-free usage for the life of your boat.

No-feedback steering system maintenance should include the following:

- After the first few hours of operation and at regular intervals, check all fasteners and the complete steering system for security and integrity.
- Check all moving parts to be sure they are free of salt build-up and other foreign material. Such build-up will affect their operation.

No-Feedback Steering (Typical)
Fig. 2.12.1

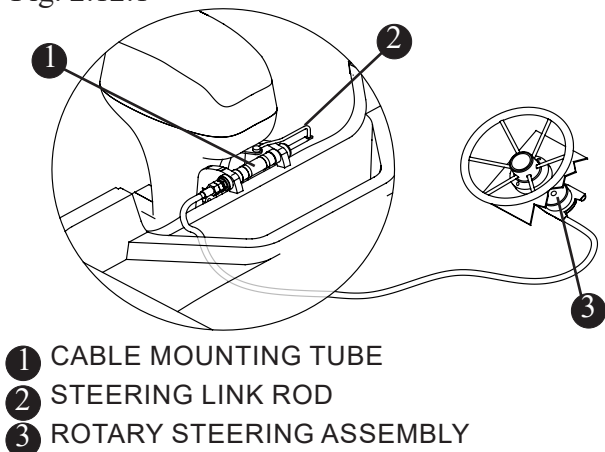

Steering Pull

Propeller steering torque will cause your boat to pull in one direction. This steering torque is a normal result of your outboard not trimmed with the propeller shaft parallel to the water surface. The trim tab can compensate for this steering torque in many cases and can be adjusted within limits to reduce any unequal steering effort.

Trim Tab Adjustment

Operate your boat at normal cruising speed, trimmed to desired position. Turn your boat left and right and note the direction the boat turns more easily.

If adjustment is necessary,

- Loosen the bolt on the underside center of the tab.

NOTE: Make small adjustments at a time.

- If boat turns more easily to the right, move the trailing edge of the trim tab to the right.
- If boat turns more easily to the left, move the trailing edge of the trim tab to the left.
- Retighten bolt and retest.

Steering Tri
Fig. 2.12.2



REFER TO THE ENGINE MANUFACTURER'S MANUAL IN YOUR OWNER'S MANUAL PACKET FOR COMPLETE INSTRUCTIONS AND WARRANTY.

Propeller

NOTICE

- **It is advised that you always carry a spare propeller, propeller hardware and propeller wrench on board. Should your propeller become damaged it can then be easily replaced.**
- **Under no circumstance should you use a propeller which allows the engine to operate at a higher than recommended RPM.**
- **Changes to the boat, such as the addition of bottom paint, additional equipment, etc. will affect performance.**

The engine on your 160 Super Sport has been equipped with a propeller which our tests have shown to be best suited for general use under normal conditions and load. In some situations you may wish to change the propeller to give your boat slightly different performance characteristics.

Propellers have two basic characteristics, diameter and pitch.

Diameter is that distance measured across the propeller hub from the outer edge of the 360° that is made by the propeller's blade during a single rotation.

Pitch is that distance in inches that a propeller will travel if rotated one revolution without any slippage.

In general, changing to a lower pitch propeller will increase acceleration and load pulling capability, with a slight decrease in top end speed. If you choose to change propellers, the type should be discussed with your Boston Whaler® dealer. All propellers are designed to provide maximum forward thrust, consequently, the reverse thrust of the propeller will not be as efficient.

⚠ DANGER

If equipped with a battery switch, disconnect power by moving the battery switch to the "OFF" position prior to removing the propeller.

Propeller Pitch & Diameter

Fig. 2.13.1

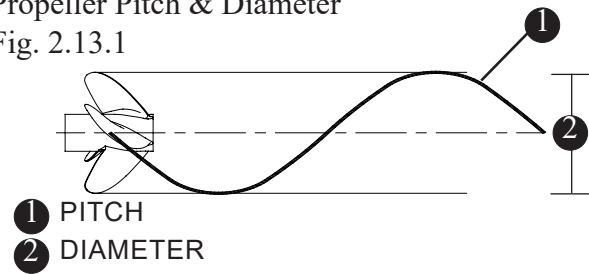

- ① PITCH
- ② DIAMETER

Lifting, Towing and Trailing

Lifting

Your 160 Super Sport is fitted with a bow eye, a bow cleat, two (2) stern cleats and two (2) stern eyes. The bow eye is located in the anchor locker.

The stern cleats are located inboard, on the transom (P&S). The stern eyes are located outboard on the transom (P&S).

These are the primary points used for lifting and securing your boat. The best knot for securing your boat would be a bowline knot. This knot is strong and can be easily removed when necessary. Always use the external stern eyes for securing the boat to the trailer.

Figure 2.14.1 shows the correct method for tying a belaying knot, commonly used to secure a boat to a dock cleat. This knot will hold fast and is simple to release when needed.

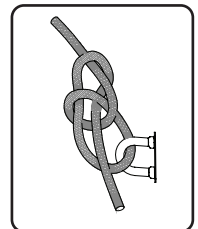

Lifting

Fig. 2.13.2

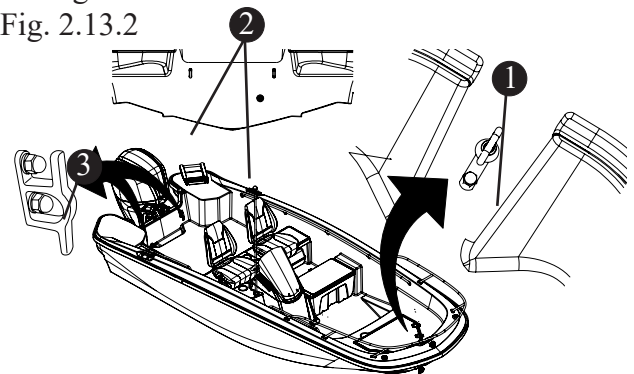

- ① BOW (LIFTING) EYE (INSIDE ANCHOR LOCKER)
- ② STERN EYE (P&S)
- ③ STERN CLEAT (P&S)

Belaying Knot

Fig. 2.14.1

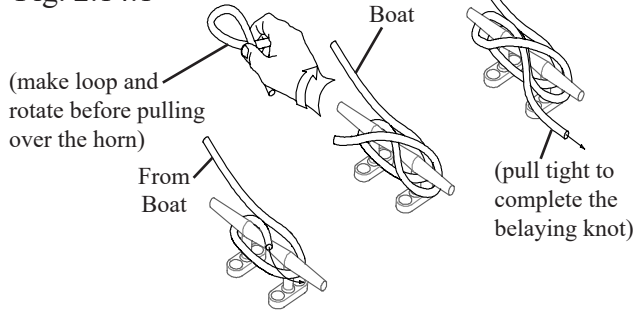

Towing

You will have to experiment to determine which towing method will work best for your specific requirements. In some cases, a single tow line will be sufficient. Other cases may require a bridle from the transom of the larger vessel or a double bridle going back to the bow eye to reduce yawing. You will have to experiment with the tow line to achieve the boat's best ride behind the wake. It is wise to attach a separate security line from the bridle or tow line to the interior cleat. This line should be loose and not take any strain from the tow. This will act as a shock preventer should the bow eye fail or the towing bridle connections let go. Although the bow eye is reinforced, high speed towing in rough water conditions should be avoided as constant heavy jerking could loosen the bow eye.

Bow Tow Eye (Option)

! WARNING

PERSONAL INJURY HAZARD

Towing or being towed stresses the boat(s) hardware and lines. Failure of any part can seriously injure people or damage the boat(s).

DO NOT stand directly in line with the tow line. If it were to break, it would "snap Back" causing injury or damage to everything in its path.

The optional bow tow eye which is located on the hull, extreme front of the boat, is reinforced with a stainless steel backing plate located in the anchor locker.

Bow Tow Eye (Option)

Fig. 2.14.2

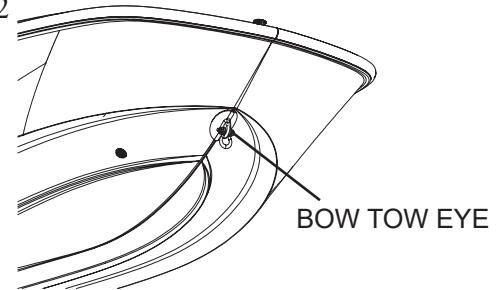

In the event that it becomes necessary for you to have your boat towed, the U.S. Coast Guard or a private salvage company experienced in this type of operation are better equipped to perform the service.

Use another recreational boat only as a last resort. Doing so may cause damage to one or both boats due to operator inexperience or other conditions such as weather and/or current.

In addition, the pitch of most propellers on average recreational vessels is geared toward maximizing the speed of the vessel, not torque, thus making towing inefficient and stressful on the engine.

! CAUTION

NEVER use the tow eye to remove your boat or another vessel which has run aground or for any other usage that would apply similar extreme forces to your boat.

Out of Water Lifting

Whether you are lifting your boat out of the water for routine maintenance or long term storage, consider the following:

- If you are using a professional lifting service, it is prudent to check all credentials and ask for proof of insurance to protect your investment.
- Use a wide, flat, belted sling for lifting, to minimize stress on the gunwales. Careful location of the sling is required. **DO NOT PLACE SLINGS WHERE UNDER WATER FITTINGS WILL BE IN CONTACT.**

CAUTION

Long term lifting with the bow and stern eyes or with the bow locker eyelet can cause stress on the fiberglass and gel coat and is not recommended.

- If using a lifting hook, attach to bow eye and the stern lifting eyes mounted on the transom. Always use a spreader bar on the stern eyes and use chafing protection on the top of the transom.
- All drain plugs (i.e. transom, fishwell, deck, etc.) should be pulled out and the boat positioned with the bow slightly higher than the stern so that any water which is allowed to accumulate in the cockpit and/or bilge can easily drain from the boat.

Trailer

NOTICE

It is your responsibility to trailer correctly. Each state has different requirements. Check with your state agency for the specific requirements for trailering in your state.

The 160 Super Sport has a trailer which is best suited for length and width of the boat. If you have a trailer or plan on purchasing a trailer separately, there are some points you need to consider, such as:

- Having a center roller and keel guards will help provide good support for the keel, also provide good fore and aft support.
- Trailers equipped with rollers instead of bunks can damage the foam sandwich hull of your boat and should never be used.
- Bunks provide a more even weight distribution.

NOTICE

Your warranty may be void if you use a trailer with rollers. Use a trailer with bunks ONLY

Trailer Safety

Securing the Boat to the Trailer

Safety Chain/Cables - There is a safety chain/cable that attaches to the bow eye and will keep the boat from sliding off the trailer in the event that the winch strap or cable breaks. **Hook this up first.**

Tie-Down Straps - Can be used to secure the boat from the stern. The tie-down straps hook into the tie-down loops on the trailer frame and to the stern eyes on the transom. Padding (or similar) chafe protection should be used wherever the tie-down straps come in contact with the hull.

Securing the Trailer to the Tow Vehicle

Safety Chains/Cables - Safety chains/cables are also important; the chains/cables are connected to the trailer and should be of sufficient length to reach the frame of the tow vehicle and should be long enough to allow the tow vehicle to turn without binding or tensioning. Attach the chains/cables by crisscrossing them under the tongue of the trailer and then attaching them to the tow vehicle.

Trailer Hitch - A properly matched trailer hitch ball and coupler is important. Make certain that the coupler and the hitch ball are properly seated and locked.

DANGER

Tie-down straps should never be used by themselves, they are only used to help in keeping the boat secured to the trailer. Make certain that the safety chain is properly secured to the bow eye.

Section 2 • General Information

Outboard Engine

It is best to trailer your boat with the outboard tilted down in a vertical operating position.

However, if additional road clearance is required due to railroad crossings, driveway clearance, trailer bounce, etc., the outboard should be tilted up and supported using an accessory outboard support device.

Your Boston Whaler® dealer will have recommendations regarding the support of your engine.

⚠ CAUTION

DO NOT rely on the power trim/tilt system or tilt support lever on your outboard to maintain proper ground clearance for trailering. **THE OUTBOARD TILT SUPPORT LEVER IS NOT INTENDED TO SUPPORT THE OUTBOARD FOR TRAILERING**

Trailer
Fig. 2.16.1

NOTICE

If you have been in saltwater, the single most important maintenance step for your brakes is to flush them thoroughly with fresh water.

- ① SAFETY CHAINS/CABLES
- ② TONGUE/BALL HITCH RECEIVER
- ③ TONGUE BALL LATCH
- ④ WINCH
- ⑤ WINCH HOOK/STRAP
- ⑥ WINCH SAFETY CHAIN
- ⑦ KEEL GUIDE ROLLER
- ⑧ BUNKS
- ⑨ TAIL LIGHT (P&S)
- ⑩ TONGUE JACK

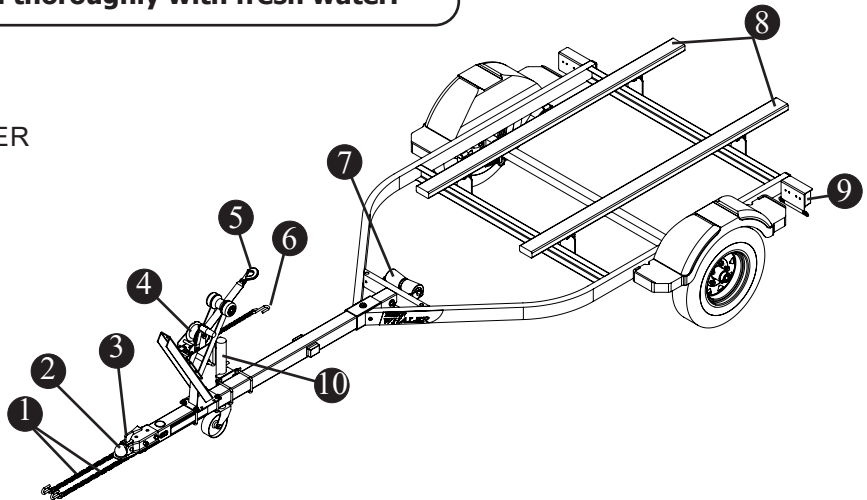

Fuel System

The 160 Super Sport is equipped for a gasoline fuel system. There are two 6.5 Gal.(24.6 L) removable fuel tanks located on the port side under the bench seat. A strap is used to secure the tanks to the deck.

It is recommended that you follow all instructions regarding the filling and transporting of the removable fuel tanks.

⚠ CAUTION

FOLLOW THE ENGINE MANUFACTURER'S RECOMMENDATIONS REGARDING THE TYPES OF FUEL AND OIL TO USE. Use of improper fuel can seriously damage your engine. Engine damage resulting from use of improper fuel is considered misuse of engine and will void the warranty.

⚠ CAUTION

Be sure fuel tanks are secured to the deck while underway.

A fuel tank with levels less than 1/4 full can cause engine stalling problems due to fuel starvation or by allowing sediment and dirt to enter the fuel supply lines. Keep the tank full and monitor the fuel level often to prevent this from happening.

NOTICE

Remove portable tank from boat and fill from shore. When fueling is complete, secure tank to deck with strap provided.

Primer Bulb

Use the primer bulb (See “Starting the Engine, page. 3-5) to draw fuel from the tank to the engine when connecting the portable tank or when fuel has been drained from the system. There are instructions regarding proper use of the primer bulb in the engine manufacturers handbook.

Fuel tank
Fig. 3.1.1

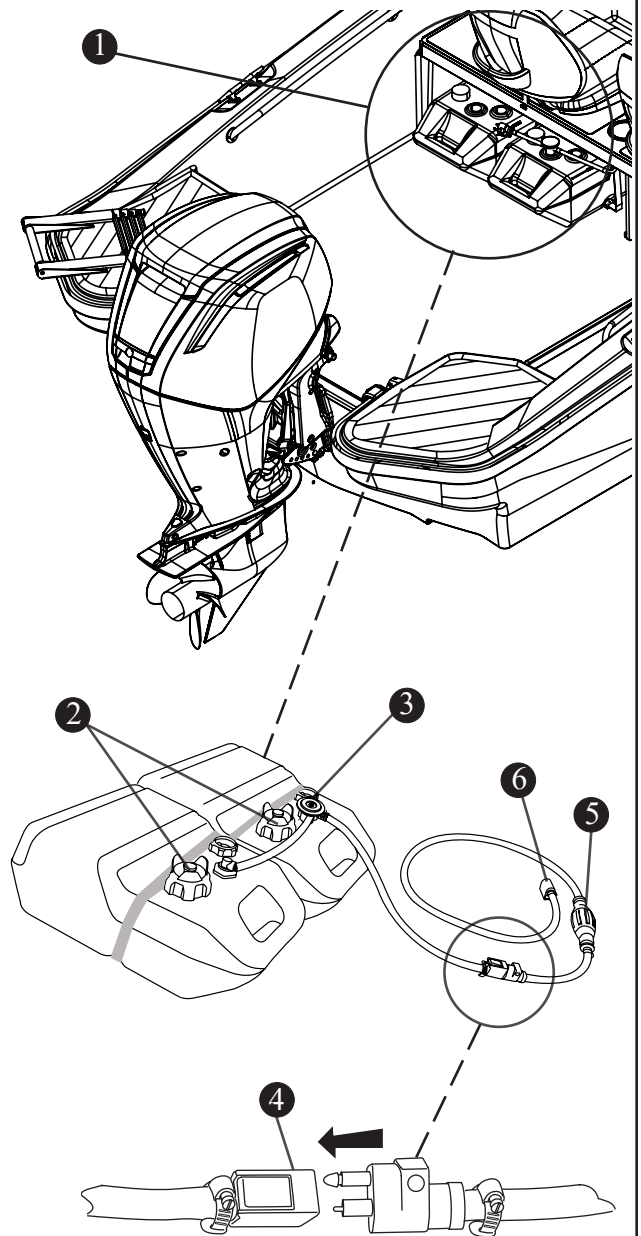

- ① DUAL 6.5 GAL (24.6 L) PORTABLE FUEL TANKS*
- ② FUEL FILL CAP WITH 2-WAY VENT
- ③ FUEL DEMAND VALVE
- ④ QUICK DISCONNECT
- ⑤ PRIMER BULB
- ⑥ ENGINE CONNECTION

* Optional fuel:
Single 6.5 (24.6 L) fuel tank

Oil Usage

Mercury or Quicksilver SAE 10W-30 multi-viscosity 4-stroke outboard oil for general, all-temperature use is recommended. NEVER use 4-cycle engine oil that is not certified to meet or exceed any one or combination of the following American Petroleum Institute (API) Service Classification SH, SG SF, CF-4, CE, CD, CDII. Severe engine damage may result from use of an inferior oil.

- SAE 10W-30 viscosity oil is recommended for use with all temperatures.
- SAE 25W-40 viscosity oil may be used at temperatures above 40° F (4° C).

DO NOT overfill. Be sure the outboard engine is upright, (not tilted) when checking oil. Follow the filling directions listed in the *Outboard Operation, Maintenance & Warranty MANUAL*.

Fuel & Oil Spillage

Regulations prohibit discharging fuel or oily waste in navigable waters. Discharge is defined as any action which causes a film, sheen or discoloration on the water surface, or causes a sludge or emulsion beneath the water surface. A common violation is bilge discharge. Violators are subject to severe penalties and may also be responsible for the cost of clean up, which can be substantial.

Use rags or sponges to soak up fuel or oily waste, then dispose of them properly ashore.

Avoid fuel spills by filling the portable fuel tanks less than rated capacity, allowing for fuel expansion.

Static Electricity and the Fuel System

There is a danger that static electricity can ignite gasoline vapors that have not been ventilated outside an enclosed area. Use extreme caution when fueling your boat from a source outside the regular venues, (e.g. marinas, fuel service stations).

Your boat's bonding system protects it from creating and discharging static electricity. Your boat must be in contact with the water or a land-based grounding system. The following suggestions will help keep

DANGER

- **Static electricity can ignite gasoline vapors causing serious injury or death and/or destruction of property.**
- **Check for leaks in tubing, connections and hoses. Avoid all forms of ignition when the odor of fuel is noticed.**

Correct the cause of the leaks and ventilate the area to insure that no fumes remain prior to energizing any electrical equipment, smoking and/or starting the engines.

you safe from static electricity while refueling your boat.

Your boat has safety features that can be circumvented by not adhering to standard fueling practices.

- **NEVER** fuel your boat in unsafe conditions such as suspended on a sling or in a situation that increases the likelihood of static discharge.
- **NEVER** use homemade containers to fill your fuel tanks.
- Fuel carried on-board outside of a fixed fuel system should be stored in an approved container or in a portable tank such as provided for outboard engines and be stowed safely outside of the engine or living compartment(s).
- Shut down the engine, motors and fans prior to taking on fuel. Any ignition sources should be extinguished before filling the fuel tank.
- Close all ports, windows, doors and hatches.
- Fueling should never be done at night except in well-lighted areas.
- Always keep the fuel nozzle in contact with the fuel fill plate or the edge of the fuel tank opening throughout the filling process.
- Allow areas where gasoline vapors could collect to be ventilated before starting the engine.
- Wipe any spillage completely and dispose of rags or waste on shore.

Section 3 • Systems & Components Overview & Operation

- Secure the fill cap tightly.
- Portable tanks should only be filled while on shore, never on board the boat.

Ethanol-Blended Fuels

Ethanol is an oxygenated hydrocarbon compound that has a high octane rating and therefore is useful in increasing the octane level of unleaded gasoline.

NOTICE

The use of improper gasoline or additives can damage your fuel system and is considered misuse of the system. Damaged caused by improper gasoline or additives WILL NOT be covered under warranty.

The fuel-system components of your Mercury engine(s) have been tested to perform with the maximum level of ethanol-blended gasoline (10% ethanol) currently allowed by the EPA in the United States.

Special precautions should be considered with the use of fuel containing ethanol in your system. Fuels with ethanol can attack some fuel-system components, such as tanks and lines, if they are not made from acceptable ethanol-compatible materials. This can lead to operational problems or safety issues such as clogged filters, leaks or engine damage.

Your boat was manufactured, and shipped from the factory, with ethanol-compatible materials. Before introducing gasoline with ethanol into your fuel tank, ask your dealer if any components have been added or replaced that are not recommended by Boston Whaler, Mercury or may not be ethanol-compatible.

Filling The Tank

It is best to maintain a full tank of fuel when the engine is not in use. This will limit exposure of the ethanol in the fuel to humidity and condensation.

CAUTION

The use of fuels containing ethanol higher than 10 percent (E-10) can damage your engine and/or fuel system and will void the warranty.

E85 FUELS COULD SERIOUSLY DAMAGE YOUR ENGINES AND MUST NEVER BE USED.

Phase Separation

Humidity and condensation create water in your fuel tank which can adversely effect the ethanol blended fuel. A condition called phase separation can occur if water is drawn into the fuel beyond the saturation point. The presence of water in the fuel beyond the saturation level will cause most of the ethanol in the fuel to separate from the bulk fuel and drop to the bottom of the tank, significantly reducing the level of ethanol in the fuel mixture in the upper level (phase). If the lower level (phase), consisting of water and ethanol, is deep enough to reach the fuel inlet, it could be pumped directly to the engine(s) and cause significant problems. Engine problems can also result from the reduced ethanol/fuel mixture left in the upper phase of the tank.

Example of Phase Separation
Fig. 3.3.1

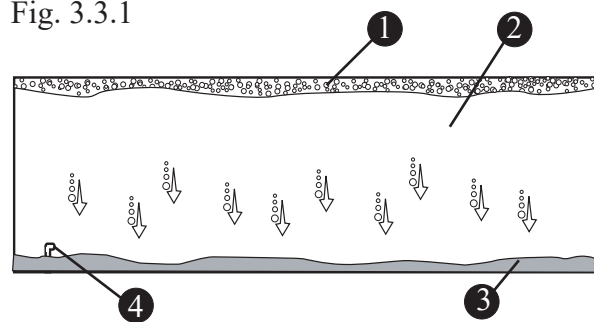

- 1 CONDENSATION
- 2 UPPER PHASE (WATER+FUEL+ETHANOL)
- 3 LOWER PHASE (WATER+ETHANOL)
- 4 FUEL INLET TO ENGINE

Additives

There is no practical additive known that can prevent or correct phase separation. The only solution is to keep water from accumulating in the tank.

If phase separation does occur, your only remedy is to drain the fuel, clean and dry the tank completely and refill with a fresh, dry load of fuel.

Fuel Filters

Mercury already provides the appropriate level of filtration to protect the engine from debris. The addition of another *in-line* filter to the system may create a possible flow restriction that can starve the engine(s) of fuel. It is advisable to carry extra *on-engine* filters in case filter plugging from debris in the fuel tank becomes a problem during boating.

Your Boston Whaler dealer will have recommendations regarding filters that meet Mercury's specifications.

Fuel/water Separator (Option)

If equipped, the addition of the optional fuel/water separator has been determined to be within Mercury specifications and will not restrict the flow of adequate fuel to the engine(s).

Maintenance

Periodically inspect for the presence of water in the fuel tank. If any is found, all water must be removed and the tank completely dried before refilling the tank with any fuel containing ethanol.

NOTICE

It is your responsibility to read and understand the engine manufacturer's manual in your owner's manual packet for complete fuel and fueling information and warnings.

CAUTION

- Oil and fuel spills can be dangerous and can subject offenders to severe penalties
- Leaking fuel is a fire and explosion hazard, inspect the system regularly. Examine fuel tanks and exposed lines for leaks and corrosion.

Fuel Systems with Portable tanks

The tag (Fig. 3.4.1) attached to the fill cap on your portable tank contains hazard and operational information. DO NOT ignore warnings or operational procedure.

Portable Fuel Tank Hang Tag
Fig. 3.4.1

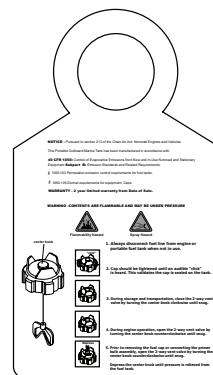

Prior to removing the fuel cap or connecting the primer bulb assembly, open the 2-way vent valve by turning the center knob counterclockwise until snug.

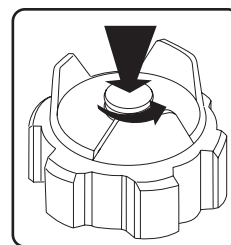

Depress the center knob until pressure is relieved from the fuel tank.

Storage

Disconnect the fuel line while in storage or transportation.

To prevent air from entering the tank, close the vent of your portable tank by turning the center knob clockwise until snug.

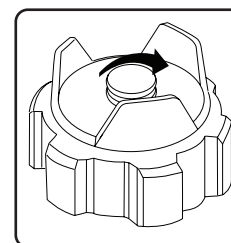

NOTICE

Long periods of storage and/or non-use, common to boats, create unique problems. When preparing to store a boat for extended periods, of two months or more, it is best to completely remove all fuel from the tank(s).

⚠ **DANGER**

Always disconnect fuel line from engine or portable fuel tank when not in use.

REFER TO THE ENGINE MANUFACTURER'S MANUAL IN YOUR OWNER'S MANUAL PACKET FOR COMPLETE INSTRUCTIONS.

Starting the Engine

⚠ **CAUTION**

NEVER start or operate your engines (even momentarily) without water circulating through all the cooling water intake holes in the gearcase to prevent damage to the water pump (running dry) or overheating of the engine.

Prior to Starting

Be sure you have read the Pre-Starting Check List, Special Operating Instructions and engine Break-In Procedure in the Operation Section of the engine manufacturer's manual which can be found in your owner's packet.

- Operator should know boating safety, safe navigation, and boat operating procedures.
- Make sure that the lower unit of the engine is in the water.

- Ensure that cap is tightened until an audible "click" is heard. This validates the cap is sealed on the tank.

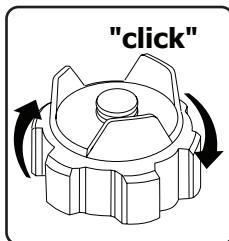

- Open vent screw in cap by turning counterclockwise.

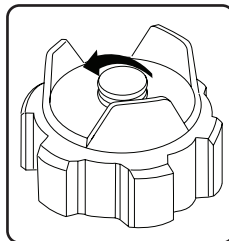

- Connect fuel line fuel quick disconnect fitting.

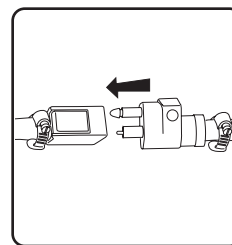

- Squeeze the fuel line primer bulb several times until it feels firm.

NOTE: To prevent flooding, do not squeeze the primer bulb after engine has warmed up.

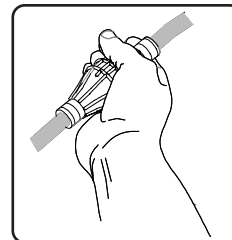

- Be sure the Engine emergency stop switch is in the "RUN" position.

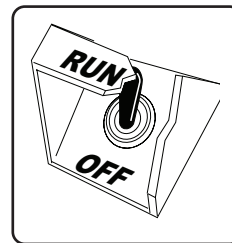

- Be sure gear shift and throttle control levers are in the NEUTRAL position.

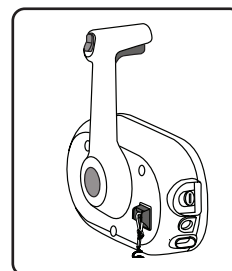

DO NOT engage "Throttle Only" feature for initial starting.

- If equipped, turn battery switch ON.

NOTICE

The gear shift/throttle control levers will not allow engine starting if the control levers are in any other position than NEUTRAL.

NOTICE

Outboards with battery charging capabilities must not be operated with battery cables disconnected from the battery. Damage to the charging system may result.

Start Engine

The ignition for the 160 Super Sport is located on the aft of the gear shift/throttle control unit.

- Turn key to “Start” position and hold until engine starts.
- When engine starts, release key. The key will return to the “ON” position.
- Check for a steady stream of water flowing out of the water pump outlet.

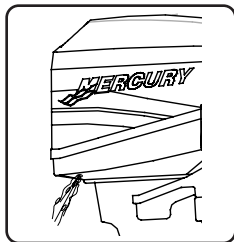
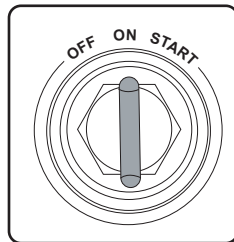
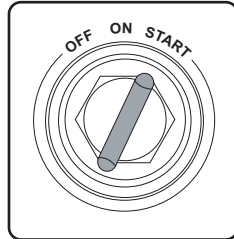
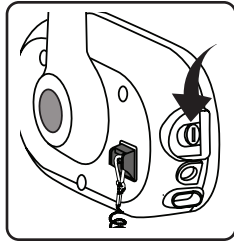

NOTE: If no water is coming out of the water pump outlet. Stop the engine and check cooling water intake for obstructions. No obstruction may indicate a water pump failure or blockage in the cooling system. These conditions will cause the engine to overheat. Have the engine checked by your dealer. Operating the engine while overheated will cause engine damage.

Warming Up Engine

The “Fast Idle” lever on the gear shift/throttle control allows the operator to increase engine RPM for warm-up without shifting the engines into gear.

- Be sure that the gear shift and throttle control handle is in the NEUTRAL position.
- Start the engine.

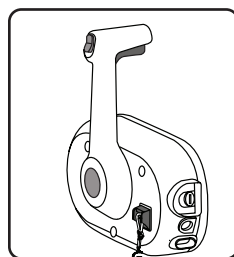

NOTICE

- **NEVER** shift outboard into gear unless engine speed is at idle.
- **DO NOT** shift outboard into reverse when the engine is not running.
- **When shifting, always stop at neutral position and allow the engine speed to return to idle.**

Stopping Engine

- Reduce engine speed and be sure that the gear shift and throttle control handle is in the NEUTRAL position
- Turn Key to the “OFF” position.

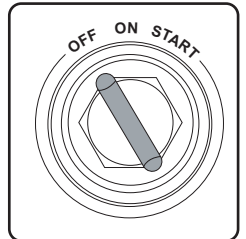
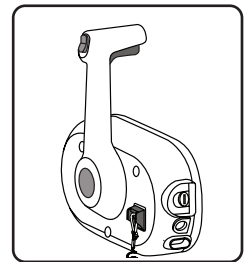

REFER TO THE ENGINE MANUFACTURER'S MANUAL IN YOUR OWNER'S MANUAL PACKET FOR COMPLETE INSTRUCTIONS.

VesselView MOBILE (Option)

If equipped, VesselView MOBILE connects the SmartCraft data network to your iPhone or android mobile device via Bluetooth. With VesselView MOBILE you have the power of SmartCraft on your mobile device with all the digital data your engine supports plus new features such as:

- Maintenance reminders
- Mapping
- Performance summary
- Fault code diagnostics

Bow Cushion (Option)

The addition of the bow cushion provides a large comfortable area for sitting and lounging.

Bow Cushion (Option)

Fig. 3.7.1

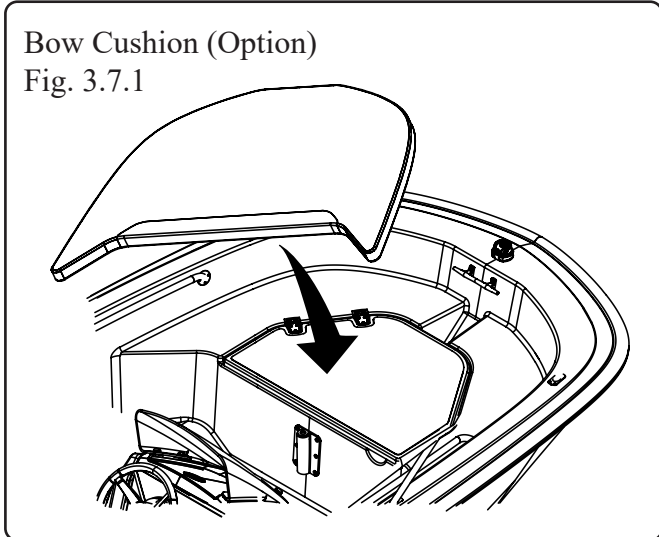

Installing Bow Cushion

Lay the cushion in place and press the snaps onto the snap receivers around the perimeter of the cushion.

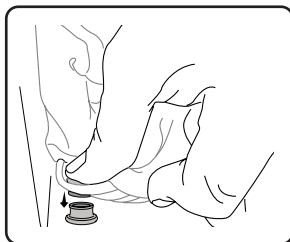

Place forward strap through the anchor locker lifting eye and buckle. Pull the strap to snug the cushion to the deck.

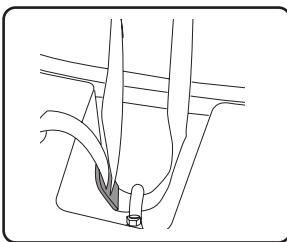

Bench Seat Cushions (Option)

The bench cushions provide comfortable sitting for the captain and a companion.

Bench Seat Cushions (Option)

Fig. 3.7.2

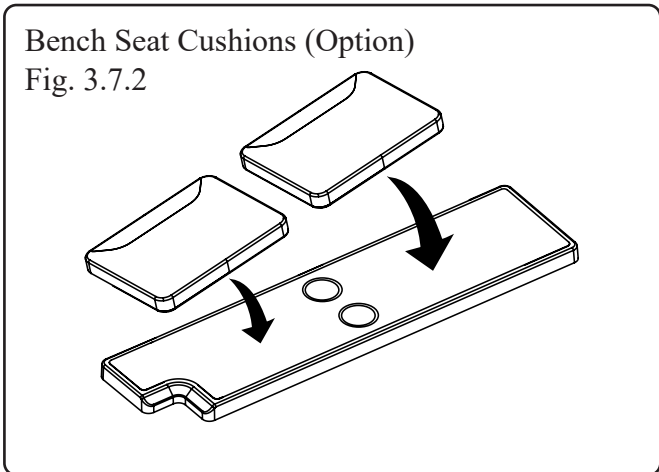

Installing the Bench Seat Cushions

Wrap the fabric flap under the edge of the bench and press the snaps (3 forward and aft) onto the snap receivers.

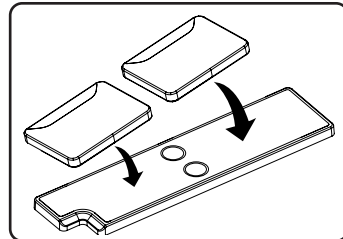

Sport Bench Seat (Option)

The Sport Bench Seat adds a classic style to your boat and is dealer installed.

Sport Bench Seat (Option)

Fig. 3.7.3

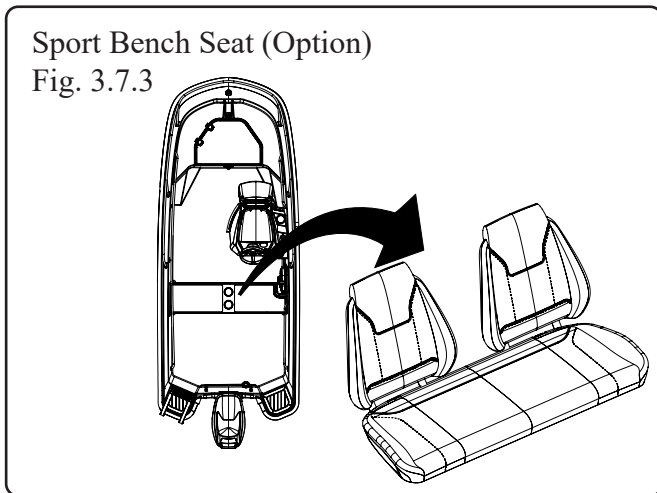

Console Side Cooler (Option)

The console side cooler is seated into a formed bracket which secures it in place.

Console Side Cooler (Option)

Fig. 3.7.4

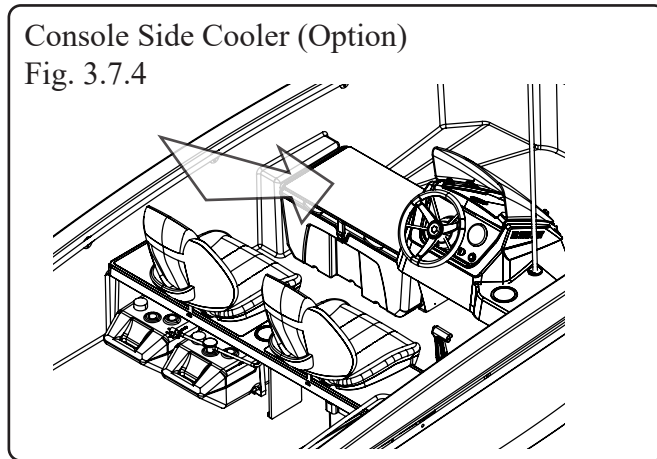

Section 3 • Systems & Components Overview & Operation

Side Cooler Cushion (Option)

Fig. 3.8.1

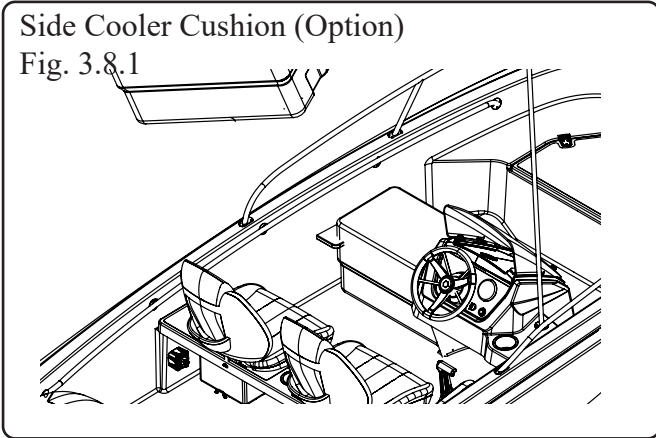

Console Side Cooler Cushion (Option)

The addition of the side cooler cushion provides an extra comfortable area for sitting and lounging.

Installing the Side Cooler Cushion

Lay the cushion in place and press the snaps onto the snap receivers on the cooler.

Sun Top (Option)

The optional sun top provides the occupants some protection from the sun or inclement weather.

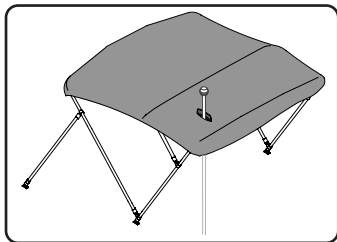

To Raise the Sun Top

- Remove sun top from boot.

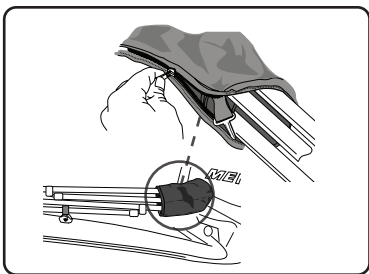

- Unclip aft support legs.

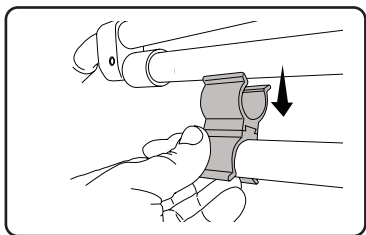

- Raise sun top to upright position.

- Insert aft support leg into bracket on gunnel.

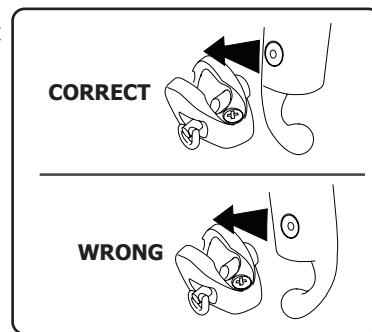

- Push the spring loaded retaining pin from the cockpit side, turn the pin so that the groove on the pin inside the bracket is facing downward.

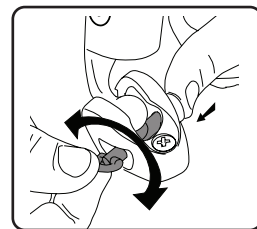

- Release the pin. This will hold the support leg firmly in the bracket.

- Attach the forward tension straps to the brackets on the cockpit side of the gunnel.



NOTE: Before attaching the straps, twist the straps a couple of turns to reduce noise from vibration when making way.

Rail Mounted Rod holder (Option)

The rail mounted rodholder is removable and can be adjusted and positioned at any point on the rails with ease.

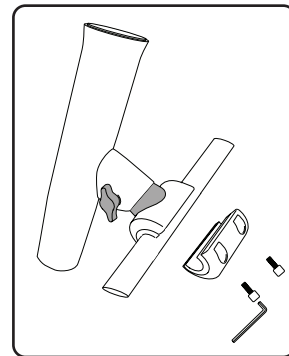

Swim Ladder

The retractable swim ladder is located on the aft port platform of your boat (See Fig. 2.8.1).

To deploy the swim ladder:

- Remove the bungee strap.

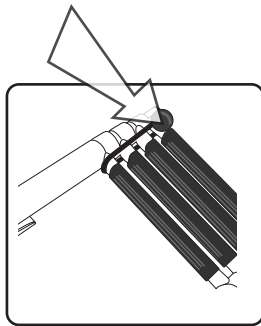

- Lift and rotate the ladder toward the aft of the boat.

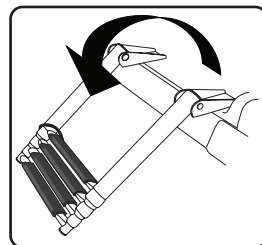

- Extend the ladder to its full length.

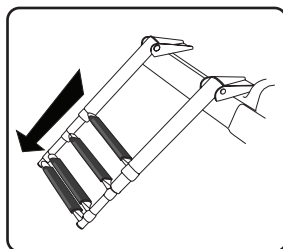

Ski Tow (Option)

If equipped, the ski tow provides for recreational skiing and wakeboarding.

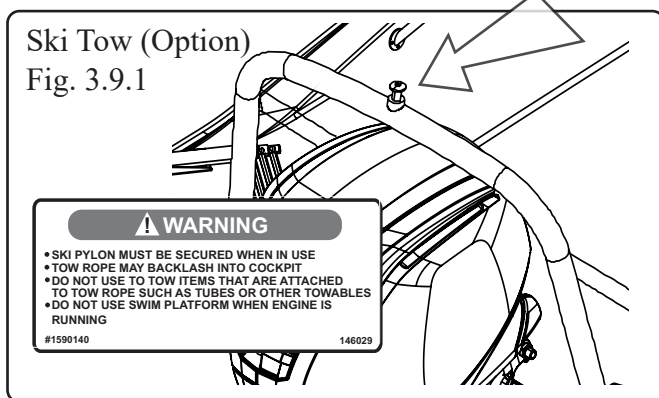

CAUTION

DO NOT USE THE SKI PYLON WITH ANY EQUIPMENT WHICH IS TIED TO THE TOW ROPE!

The ski pylon is for skiing and/or wakeboarding ONLY. If engaged in tubing or such other recreational towing, it is recommended that you attach the tow rope to the stern eyes at the transom of your boat.

Anchoring

NOTICE

Anchor light must be on when at anchor or drifting (not under power) at night or in low visibility.

Bow Light w/Rope Guide

The bow light on your boat features a shim on the base which helps guide the anchor rope around the nav light to avoid damage to the light when lowering or weighing the anchor.

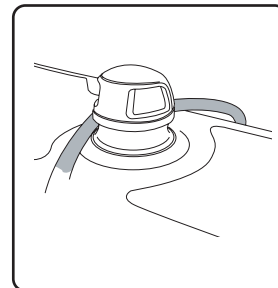

The 160 Super Sport is equipped with an anchor storage compartment located in the bow of the boat. Because there are a variety of anchors, with a variety of uses, **discuss the types of anchors with your dealer to find the right anchor for your boat.**

WARNING

SWAMPING HAZARD - Anchor from the bow if using one anchor. A small current can make a stern anchored boat unsteady. A heavy current can drag a stern anchored boat underwater.

Considerations

- Wind and sea conditions can affect the boat.
- Because the boat is not moving through the water, there is no control.
- Be sure that the anchor will hold under all circumstances if you are leaving the boat.
- Understand the principles of rode and scope and their effect on anchor performance.

Proper anchoring requires knowledge of RODE and SCOPE and understanding the relationship between rode, scope and anchor performance.

The **rode** is the line connecting the anchor to the boat. Nylon line is ideal because it is light, strong

Section 3 • Systems & Components Overview & Operation

and stretches, it also can be stored wet and is easy to handle. Add a length of chain between the anchor and the nylon line to aid in setting of the anchor.

The scope is technically defined as the ratio of rode length to the vertical distance from the bow to the sea floor. Scope also depends on the type of anchor, tides, winds, sea conditions and type of sea floor the anchor is in. Since you want to know how much rode to use when anchoring, use this common formula:

Rode length = (bow height + water depth) X Scope.

The minimum is 5:1 for calm conditions; normal is 7:1, and severe conditions may require a 10:1.

Example:

$$\text{Rode length} = (3 \text{ feet} + 10 \text{ feet}) \times 7^*$$

$$\text{Rode length} = 13 \text{ feet} \times 7^*$$

$$\text{Rode length} = 91 \text{ feet}$$

* Scope may range from 5 to 10 or more. However, less than 5, the anchor will break out too easily.

Lowering The Anchor

NOTICE

Before using the anchor be sure the anchor line's bitter end is secured to the eye in the bottom of the anchor locker.



CAUTION

Be careful that trailing lines do not foul in the propeller

Proper Anchoring
Fig. 3.10.1

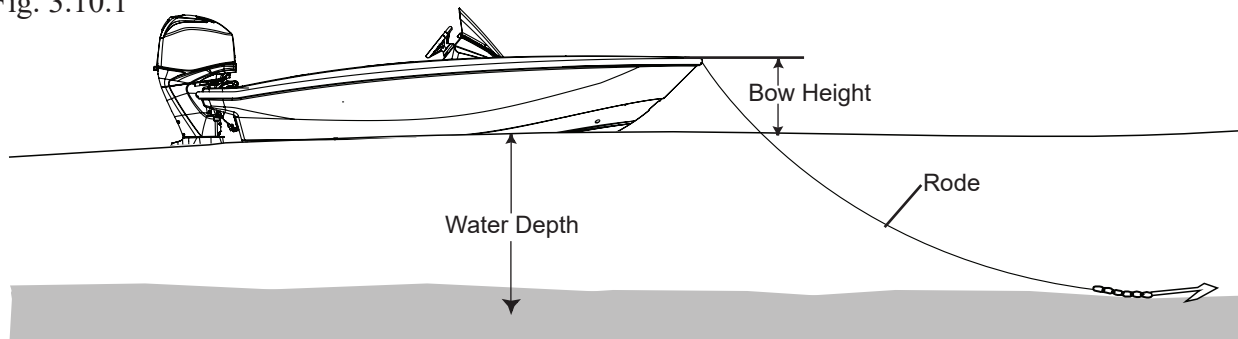

$$\text{Rode length} = (\text{bow height} + \text{water depth}) \times \text{Scope}$$

- Be sure there is adequate rode.
- Secure rode to both the anchor and the boat at bow locker eyelet.
- Stop completely before lowering the anchor.
- Keep feet clear of lines.

Setting the Anchor

There is no best way to set an anchor. Experiment to see how it performs. One method is to turn the rode around a bitt or a cleat and slowly pay out as the boat backs from the anchor site. When the proper scope has been reached snub the rode quickly, causing the anchor to dig in to the sea bottom.

- Reverse the engine slowly to drive the anchor in and to prevent it from dragging.
- Secure the rode to the bitt or cleat to prevent loss of anchor.

Weighing the Anchor

To weigh (retrieve) the anchor, start the boat and run slowly up to the anchor, taking up the rode as you go. The anchor will usually break out when the rode becomes vertical. Coil lines to let them dry before stowing.

Electrical Systems

DC Electrical System

The electrical system on the 160 Super Sport is powered by one battery. The battery is charged by the engine when the engine is running. The battery powers essential systems on your boat:

- Engine Ignition.
- Engine tilt trim system
- Navigation/anchor lights
- Helm gauge(s)
- Electronic and add-on accessories

Battery

NOTICE

Your battery should always be stored in the battery box.

NOTICE

REFER TO YOUR ENGINE OWNER'S MANUAL FOR EXACT BATTERY REQUIREMENTS.

The chart below is provided for reference purposes only.

| Application | Group | Volts | MCA* | CCA** | Reserve | Qty. |
|-------------|-------|-------|------|-------|---------|------|
| Engine | 24 | 12 | 465 | 350 | N/A | 1 |

*Marine Cranking Amps
** Cold Cranking Amps

Battery Box

Your battery should always be enclosed in the battery box provided with your boat and located under the starboard side of the aft bench seat

The box will contain any spilled acid, as well as protect the battery terminals from damage or inadvertent shorting from contact with metal objects.

The battery box should always be secured in place by using the straps and clamps provided, the straps will ensure that while underway the battery will not move around, causing damage to components and/or equipment stored in the same area.

⚠ DANGER

Batteries contain sulfuric acid which is dangerous and can cause serious injury. AVOID contact with skin, eyes and clothing. If contact occurs, immediately flush the affected area with large quantities of water and call for medical assistance.

Battery Box
Fig.4.1.1

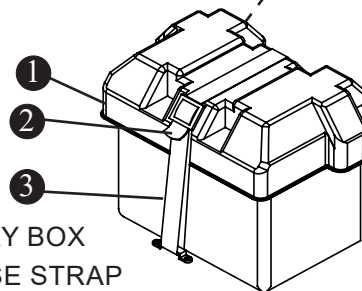
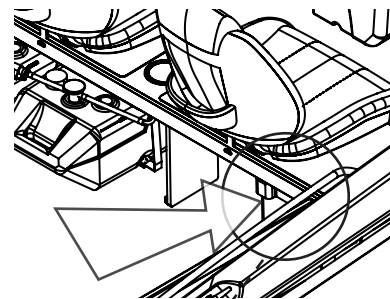

- 1 BATTERY BOX
- 2 RELEASE STRAP
- 3 TIE-DOWN STRAP

Before use, check the battery for loose connections or wiring. Normal maintenance should include:

- Coating the terminals with dielectric grease
- Keeping the battery dry
- If not using a sealed battery, check & maintain the water level. USE DISTILLED WATER ONLY.
- Removing the battery from the boat during cold weather or long term storage.

The most life shortening experience for the battery is to be drained to zero charge before recharging.

When a battery discharges, the active material on both positive and negative plates converts to lead sulfate, causing the plates to become more alike in an electrical charge. The electricity conducting battery

! CAUTION

- **NEVER** use an open flame in the battery storage area.
- **Avoid striking sparks near the battery.**
- **A battery will explode if a flame or spark ignites the free hydrogen given off during charging.**
- **ALWAYS** disconnect the battery before doing any work or maintenance on the electrical system.
- **NEVER** turn off the battery switches or disconnect the battery cables while the engines are running.

acid becomes weaker and the voltage drops. As the battery remains discharged, the process continues until recharging the battery becomes impossible.

If the battery does become run down be sure to recharge it as soon as possible. Over charging the battery can be just as detrimental to its life as running it down too far

Battery Switch (CE Option)

The battery switch, located on the starboard side, under the bench seat (Figure 4.2.1), allows you to control the delivery of DC power from the battery to the engine as well as allowing the alternator to charge the battery.

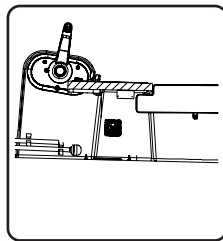

Battery Switch (CE Option)
Fig.4.2.1

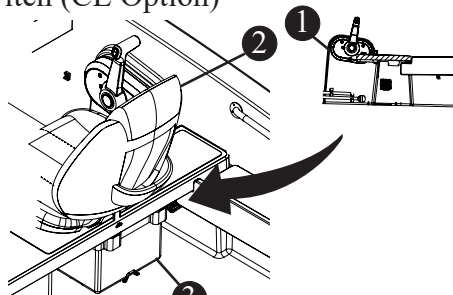

- ① BATTERY SWITCH
- ② HELM SEAT
- ③ BATTERY BOX

Your battery selector switch has two settings, “ON” and “OFF”, “ON” gives you power from the battery.. “OFF” you have no power to the engine.

Remember to turn the battery selector switch to “ON” before you attempt to start your engine.

Note: The bilge pump cannot be turned off with the battery selector switch.

! CAUTION

If equipped with a battery switch, you will need to stop the engine before moving the switch to the “OFF” position.

12 Volt Accessory Receptacle

NOTICE

DO NOT insert a cigarette lighter into the 12V receptacle. **Damage to the unit and system may occur.**

The 160 Super Sport is equipped with a 12 volt receptacle located on the starboard side of the helm.

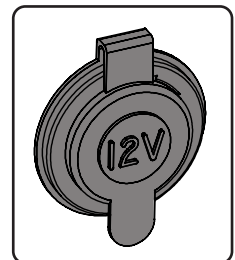

The receptacle is made of corrosion resistant marine grade materials and have a moisture proof cap.

Be sure to use accessories that do not exceed the rated capacity of the circuit, (15 amps). Doing so will cause the in-line fuse to trip.

The in-line fuse is located under the port side of the bench seat adjacent to the battery.

Navigation Lighting

The navigation lighting circuit is equipped with a 2 amp in-line fuse.

The in-line fuse is located under the port side of the bench seat adjacent to the battery.

Section 4 • Electrical System

Electrical Schematics

Boston Whaler adheres to electrical wiring requirements that meet ABYC E-11 standards. The schematics on the following pages are for reference and use by Boston Whaler service technicians. Boston Whaler reserves the right to change or update the electrical system on any model at any time without notice. In addition, Boston Whaler is not obligated to make any updates to units built prior to a change. Contact Boston Whaler customer service for current electrical schematics.

Section 4 • Electrical System

Wiring Schematic
Fig.4.4.1

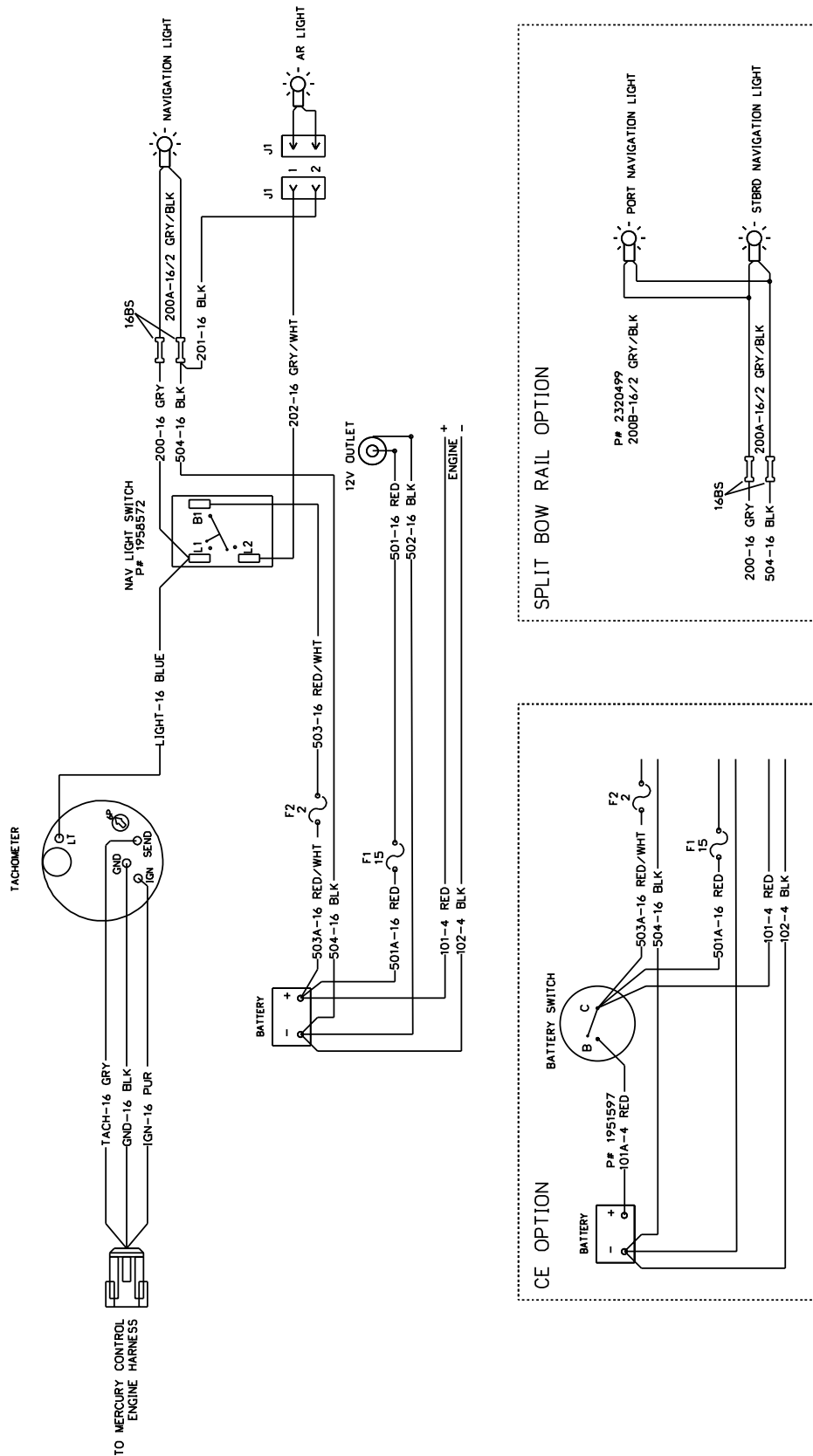

6032-07-401_B

Routine Care & Maintenance

NOTICE

Refer to the individual manufacturers' manuals for important information regarding service, care and maintenance of your boat, equipment and components. Failure to do so may in some cases void the warranty.

Owner's Manuals for your boat and each of the various components and equipment can be found in your Owner's Manual Packet.

⚠ DANGER

When using solvents read all information from the solvent manufacturer regarding safety and handling of the material.

Wear proper protective equipment to ensure your personal safety.

Only use solvents in a well ventilated area and keep all solvents away from open flame and any other forms of ignition.

Routine inspection, service and maintenance of your boat, boat systems and components are vital to assure your safety, as well as prolonging the life of your boat. You should develop regular routines for inspecting and servicing your boat.

⚠ WARNING

IMPORTANT

Regularly inspect & test hardware, fittings, windshields, hatches, seams, etc. for proper seal. Reseal and/or readjust/tighten fittings, latches, etc. as needed.

The interval between necessary service or maintenance is highly variable, depending on the environment in which your boat will be used. For example, corrosion of boat parts and components will occur far more rapidly in a salt water environment than on a boat which is used in fresh water.

This section provides only general guidelines for the care and cleaning of your boat. It is your responsibility to determine whether maintenance and care intervals need to be accelerated due to your boat usage and/or operating environment.

Hull

Fresh water, saltwater and water temperature can all affect the types of growth that you will find on your boat's hull.

Any growth will affect the boat's performance and overall look. If it has been a while between inspections you might notice algae or slime growth on the hull. This can be cleaned with a coarse towel or soft bristle brush. The growth should be cleaned immediately after the boat has been removed from the water. If the growth is allowed to dry it will be much harder to remove.

Compounding may be necessary to remove more stubborn stains and chalking from the surface of your boat. If compounding is necessary it must be done after a thorough washing and prior to waxing.

If the growth is more severe, you may need to enlist the services of a professional hull cleaning company.

Check with your Boston Whaler dealer for recommendations on a compatible rubbing compound for your boat or a professional hull cleaning company in your area.

Waxing the Gel Coat Surfaces

Waxing is necessary to provide added protection to the gel coat. A periodic good cleaning and waxing will also ensure that your boat will be protected and look good longer.

NOTICE

Waxing of the exterior surfaces is recommended to be done at least twice a year to protect the gel coat of your boat.

Do not wax over dirt. Make sure the surface of your boat has received a thorough washing and rinsing and is clean before waxing. If a rubbing compound has been necessary, make sure that any minor scratches or surface pitting is cleaned of compound residue. Use a good quality carnauba wax or a high quality wax designed for marine gel coat. Apply several coats.

Hull Maintenance

If using a pressure washer to clean the hull and deck surfaces of your boat it is important that you use the wide fan nozzle only and move the spray head in a continuous motion. Do not concentrate the high pressure on a small area of the boat surface and **NEVER** use the fine pinpoint nozzle as the concentrated stream can cause damage to the surface of your boat.

It is also recommended that you refrain from pressure washing the console as high pressure may compromise the integrity of the electronics and gauges as well as other equipment installed on your boat. Also avoid pressure washing all caulk seams.

When staining from build-up does occur, use only cleaning agents that are recommended for marine gel coat for use on those stubborn stains.

NEVER use an abrasive cleaner to wash your boat's hull.

NEVER use an abrasive pad to attempt to remove stubborn stains.

NEVER use strong solvents to clean.

NEVER apply tape or any other type of adhesives directly to the painted surfaces on your boat.

Use care when covering your boat's painted surfaces as tarps and other such covers can trap dirt and cause chafing. It is best to use a frame of either aluminum or wood to keep the cover up and allow air to circulate.

Hull Blistering

Due to the quality of the materials used in the hulls of Boston Whalers, blistering is rarely ever seen. Blistering is caused by water soluble materials in the hull laminate. The fiberglass and resin structure of your boat is porous. However, intrusion of water into the gel coat will take some time. The effect of osmotic pressure allows water to impregnate below the gel coat and substrate thus forming a blister.

There have been extensive university studies funded by the United States Coast Guard regarding the cause and effect of blistering in the gel coat of fiberglass boats. Fiberglass blisters can form anywhere from near-surface layers of the gel coat to very deep into the fiberglass structure. The damage can range from cosmetic to catastrophic, (although the latter is a very rare occurrence). The studies seemed to point toward long term immersion of the hull in warm water as a primary cause of hull blisters. Stress cracks on the hull below the waterline also contribute to the formation of hull blisters.

Prevention

There are a variety of ways to prevent the formation of hull blistering. Epoxy coatings can be applied to the hull, followed by hull painting. An alkyd-urethane-silicone marine paint can also be used to aid in the prevention of hull blisters.

Reducing the amount of time that your boat stays in the water also helps prevent hull blisters from forming. Use of a trailer or boat lift will reduce the likelihood of hull blisters forming. Be sure to use a bunk type lift or trailer for storage of the boat out of water.

Contact your Boston Whaler® dealer for more information on the prevention and treatment of hull blisters.

Bottom Painting

DANGER

There are risks and dangers inherent with the use of paints and solvents. Dispose properly of all rags, rollers and trays used for painting. Follow all the precautions and regulations listed by the manufacturer before and after painting your boats hull.

NOTICE

If blisters are present in the hull, they need to be properly cleaned and dried out before any barrier protection can be applied.

If your boat will spend most of its time in the water, painting the bottom of your boat's hull is a good way to slow the formation of hull blisters and to keep bottom growth (fouling) under control.

If you will be trailering the boat to and from the water, you might want to forgo the painting.

Following is an abbreviated section on painting your hull bottom. Your Boston Whaler® dealer should have information on properly painting your boat's hull or recommendations on businesses that will paint your hull for you.

CAUTION

Do not paint over zinc plates. This action will render them useless and lead to deterioration of the underwater metal parts of your boat.

Some bottom paints contain metals that can cause corrosion of the outboard engine. Leave a minimum of 3/4" unpainted around all engine parts. Use only a paint specifically designed for aluminum engines as anti fouling protection.

Bottom Painting a Bare Hull

Since the boat has never been painted preparation is the key to successful hull painting. Take extra care and time in preparation before proceeding to paint.

Begin by scrubbing the surface thoroughly with a stiff brush using an all-purpose marine soap and water to remove loose dirt and contamination. Flush with fresh water to remove all soap residue.

The gelcoat will have to be dewaxed of mold release wax before sanding can begin, otherwise the wax

WARNING

Proper ventilation and capture of the dust created by sanding is essential. The dust created by sanding is toxic and should not be breathed. A proper fitting respirator must be used.

DO NOT use a paper filter mask.

will be dragged into the scratches and will reduce the adhesion properties of the paint.

Remove any mold release wax that may be present using fiberglass surface prep solvent and a scrub pad. Scrub only a few square feet at a time. Flush with fresh water. If the water beads up or separates, continue scrubbing the surface. When the water sheets off, the wax contaminate has been removed.

After the dewaxing is complete, application of a primer coat is recommended. Pay close attention to scratches, nicks and dings in the surface. If necessary, fill any repair areas with a watertite epoxy filler. After filler is cured, sand with 80 grit paper until smooth. Remove the sanding residue using a fiberglass solvent wash.

The paint can be applied after sanding and cleaning is complete. Follow the paint manufacturer's recommendations for application.

Bottom Painting a Pre-Painted Hull

WARNING

Bottom paint is designed to resist algae growth which means it has chemicals embedded in the paint that are harmful if ingested. Take all necessary precautions required before painting or repainting your boat's hull.

If the hull bottom is already painted, you must be sure to test the paint's adhesion to the already painted surface. If the paints are incompatible, the new paint will not adhere to the hull bottom or the paint will "lift" the old paint. **NEVER** apply paint without first preparing the old painted surface following the paint manufacturer's recommendations.

Follow the paint manufacturer's recommendation for applying the paint. Humidity and weather will play a role in how and when the paint is applied. Several thin layers are better than one thick layer.

To determine the waterline, you will need to place the boat in water with a full load of fuel and gear. Mark the waterline and measure above the marked line 1 to 3 inches for placement of the tape line.

NOTICE

Masking tape is NOT recommended for the types of paint you will be using.

Make sure that there is enough paint left to cover areas that were not accessible, (slings, jack stands etc.) and paint accordingly. Follow the paint manufacturer's recommendation for do's and don't's after the painting is complete.

NOTICE

Painting your boat's hull will adversely affect the boat's speed and performance and may require re-propping if the maximum engine RPMs drop below the engine model/mfg recommended operating range.

Rubrail Care

The rubrail on your boat is constructed of an injected high density PVC vinyl material which laboratory tests have proven to be highly resistant to staining, fading and cracking.

As resilient as this material is, you still need to follow some basic maintenance precautions.

General maintenance requires a thorough cleaning with mild soap & water. Do not use any cleaning agents which contain chemicals.

Although the outer shell is tough and durable, there is a chance that it can be breached. Use care when docking or exposing the rubrail to conditions which may cause damage such as docking against heavily barnacle-encrusted pilings.

Some tears (cleanly sliced) can be repaired with a "Super Glue" type product.

Thoroughly clean and dry the affected area. Apply glue and hold the surfaces together.

Areas which have been torn or are affected by heavy abrasion will have to have the damaged section replaced. Please see your Boston Whaler® dealer for this type of repair.

Cleaning Fiberglass & Non-Skid

To protect your deck and non-skid areas from the deteriorating affects of the sun, oxidation, water spots and pollution, use a good quality "fiberglass and non-skid deck" wax every two to three months.

When applied to your deck and non-skid areas, as recommended by the manufacturer, the wax forms a protective non-slick surface which will keep debris from sticking. Dirt, soot, bird droppings, and even fish blood will rinse right off.

NOTICE

NEVER use abrasive cleaners, detergents or soft scrub type cleaners to wash your boats surfaces.

NEVER use abrasive pads, brushes or sponges to attempt to remove stubborn stains.

NEVER use strong solvents or detergents which contain chlorine.

Stainless Steel Care

The cleaner your stainless trim and fittings can be kept, the greater the assurance of optimum corrosion resistance. Without proper care even the best stainless steel will corrode.

Stainless steel is strong and corrosion resistant, but still requires maintenance to keep its appearance. Frequent routine cleaning of your stainless steel with a mild soap and water solution and coating with a good grade cleaning wax will help maintain the finish.

- Wash with mild soap and cold or lukewarm water.
- Dry THOROUGHLY.
- Apply cleaning wax with a soft, dry cloth.
- Allow wax to dry, then polish and buff.

Even the finest cleaning powders can scratch or burnish a mill-rolled surface. On polished finishes, rubbing or wiping should be done in the direction of the polish lines, NOT across them.

Crevice corrosion, a brownish coloring which occurs where two pieces of stainless hardware meet is caused by impurities in water and air. It can be easily cleaned with a good grade marine polish using a sponge, cloth or small bristled brush (for nooks and crannies).

NOTICE

NEVER use abrasive cleaners, detergents or soft scrub type cleaners to wash your boats surfaces.

NEVER use abrasive pads, brushes or sponges to attempt to remove stubborn stains.

NEVER use strong solvents or detergents which contain chlorine.

NEVER use silver cleaners.

Aluminum Care

Preventative maintenance is essential to life of the metals on your boat. The presence of salt particles and moisture is the major cause of white spots, pitting and corrosion.

The use of harsh chemicals can also cause deterioration. Manufacturers and applicators of protective coatings will not warrant protective coatings on metals in the marine environment. Proper owner maintenance is required to reduce deterioration which will result in most cases by failure to wash down and wipe dry after each use and/or the use of abrasive, acidic or other improper cleaners.

Wash completely using a soft cloth and mild detergent to remove salt particles. Hosing alone will not dislodge all particles. **DO NOT** allow soap to dry as it may cause stains on coated surfaces. Make sure to wash and dry the full circumference of aluminum parts.

Apply an aluminum protectorant at least twice each year, more frequently as conditions warrant. Neglect will cause pitting of the surface which cannot be reversed.

Inspect and repair or replace all damaged nylon bushings, washers or other hardware designed to prevent contact with dissimilar metals.

Whenever electrical or electronic changes are made to the boat, a qualified marine technician should check aluminum parts for stray currents. Make sure all electronic equipment is properly grounded with adequate sized wire.

Cushions

Saltwater, salt residue, dirt, ultra-violet rays etc. will take their toll on vinyl products causing them to lose their luster and texture.

The cushions on your boat are made of a durable vinyl material called OMNOVA which is protected by a finish called PreFixx[®]. PreFixx[®] will keep your cushions looking new far longer than most other vinyl upholstery.

To Clean Your Cushions

CAUTION

Solvents are flammable. Exercise proper care. Wear rubber gloves during all cleaning activity.

Use caution when cleaning around buttons, stitching and wooden or decorative trim as these solvents could seriously damage such areas.

- Remove ordinary dirt and smudges with a mild soap and water solution. Dry with a soft, lint-free cloth or towel.
- More difficult stains can be cleaned using rubbing alcohol (isopropyl alcohol). Rinse cleaned area with fresh water and dry with a clean, soft, lint-free cloth or towel.

- Seemingly permanent stains like ballpoint ink can be cleaned with active solvents such as nail polish remover when applied with a soft cloth or damp sponge and rubbed. Rinse cleaned area with fresh water and dry with a clean, soft, lint-free cloth or towel.

The vinyl material and superior finish has been tested to resist heavy abrasion. Complete cleaning instructions are included in the owner's packet. Read all information provided by the cushion manufacturer regarding the proper cleaning and maintenance.

Your cushions are not waterproof. They are constructed of open-cell foam and will absorb and hold water. Do not leave the cushions in standing water or exposed to heavy, prolonged rain.

If, in the event your cushions become waterlogged, remove the foam from the cushion, press as much water as you can from the foam and allow to air dry.

To prevent mildew, keep the vinyl dry and make sure that moisture does not accumulate between the cushions.

Cleaning Your Instrument Gauges

When gauges are exposed to a saltwater environment, salt crystals may form on the bezel and plastic covers. Remove the salt crystals with a soft damp cloth. Clean with a mild household detergent or plastic cleaner.

Never use abrasives or rough, dirty cloths to clean plastic parts. A mild household detergent or plastic cleaner should be used. Wipe clean with a damp chamois.

FOR MORE INFORMATION, CONTACT MERCURY MARINE CUSTOMER SERVICE AT 920-929-5040

Canvas Care and Maintenance

NOTICE

DO NOT use detergents, bleach or solvents to clean your canvas.

To keep your canvas and metal parts in good working condition and in good appearance, you will need to keep them clean.

The fabric should be cleaned regularly before substances such as dirt, pollen, etc. are allowed to accumulate on and become embedded in the fabric. The canvas can be cleaned without being removed from the installation.

Chafing, fiber wear from dirt and grit and deterioration from ultraviolet light can cause your canvas to degrade over time.

Maintaining a good appearance

- After each use, especially if used in salt water areas, rinse the canvas completely with fresh cold water.

On a regular basis

- Brush off any loose dirt, pollen, etc.
- Hose down with fresh cold water and clean with a mild solution of a natural soap in lukewarm water (maximum 100°F / 38°C).
- Allow the canvas to soak. Do not allow the soap to dry.
- Rinse thoroughly with fresh water.
- Let the canvas dry completely. Do not store any of the canvas pieces while wet.

The effects of ultraviolet light can sometimes be reduced by chemical treatment of canvas items.

Consult your boston whaler® dealer or check your canvas manufacturer's manual before using any chemical treatments on your canvas.

Cleaning Stubborn Stains

Soak fabric for approximately twenty minutes in a mild solution consisting of no more than 1/2 cup (4 oz.) of bleach and 1/4 cup (2 oz.) of natural soap per gallon of lukewarm water (not to exceed 100° F / 38° C).

Rinse thoroughly in cold water several times. Allow the fabric to air dry completely.

NOTICE

Failure to remove all of the soap solution can cause deterioration of seams and prevent fabric from proper retreating.

Retreat the fabric using an air curing product such as 303 High Tech Fabric Guard to ensure water and stain repellency.

All canvas should be stored flat or rolled in a clean, dry space.

Maintaining Zippers and Hardware

Lubricate zippers and fasteners periodically with a clear silicone spray. In the absence of silicone spray, a wax candle can be used to lubricate the zipper track.

Replace any missing fasteners or any fasteners showing signs of corrosion.

NOTICE

DO NOT use petroleum based products, such as petroleum jelly, on the zippers or fasteners.

Hull Wrap Care

The graphic wrapping on your boat (Option) needs the same care as any other graphic or decal. Frequently wash down with fresh water and simply wipe off any loose dirt, pollen, etc using a sponge or soft cloth.

In the event that the graphic is scraped or dinged by interaction with a dock, another vessel or any other object, the graphic wrap can be repaired (patched) by simply contacting your dealer and requesting a patch which will cover the existing design.

The boat wrap will not fade even through exposure to sun or saltwater so the colors of a patch will match the design perfectly.

Powder Coating Touch-Up

If it is necessary to apply touch-up paint on areas of the finish that have been scratched or damaged the powder material supplier should be contacted for their recommendation of the proper touch-up material to use.

Single component Acrylic Enamel (spray enamel) touch-up paint is commonly used for repair of minor damage in the powder coated finish. In some cases a two-component catalyzed paint system may be required to achieve the desired repair. In all cases, perform a color and adhesion test in an inconspicuous area of the finish to assure compatibility before applying the paint to the damaged area.

Touch-up Procedure

- Clean surface of dirt, oil, grease, etc.
- Sand lightly with 400 grit wet/dry abrasive paper.
- Remove sanding dust with a lint-free cloth dampened with mineral spirits.
- Temperature of surface and paint must be at room temperature (between 70 to 90 degrees is ideal).
- Apply paint to minor scratches by spraying a small amount of paint into the container's cap. Using a small brush, carefully apply the

NOTICE

For the best results, use Orbit Industries touch-up paint, RAL 9010 Pure White.

Orbit Industries: 800-448-3885

paint sparingly to the properly prepared surface. Do not apply a heavy coat all at once. Apply several light coats allowing the paint to dry until tacky between each coat.

NOTICE

The visual, mechanical, chemical as well as corrosion protective and weather resistance properties of repaired areas ARE NOT equal to those of the original powder coating and are not suitable for long term performance.

NOTICE

If painting over exposed or bare metal, a chemical pretreatment process and/or primer sealer is recommended.

Follow manufacturer's recommendations.

NOTICE

It is highly recommended that you DO NOT penetrate the powder coating on your boat by securing equipment or other objects onto the coated surface. If necessary, contact the manufacturer for repair recommendations.

FOR MORE INFORMATION, CONTACT APEX POWDER COATING, INC AT 864-288-2739

Long Term Storage & Winterization

Long periods of storage, winter lay-up and/or non-use, common to boats, create unique problems. When preparing to store a boat for extended periods of two months or more it is best to make sure that the boat and its systems are properly conditioned for such extended periods of non-usage.

The guidelines presented on the following pages give basic instructions on “winterizing” your boat and boat systems. If inexperienced with the process of winterization it is best to hire the services of a professional.

In addition, always consult the owner's manuals of the various systems and equipment on your boat for the manufacturer's recommendations on winterizing and long term storage.

Engine



Never start or run your outboard (even momentarily) without having water circulating through the cooling water intake holes in the gear case. This will prevent damage to the water pump (running dry) or overheating of the engine.

Protecting your engine's vital moving parts from corrosion and rust caused by freezing of trapped water or excessive condensation due to climatic changes is very important. Freezing water in the engine can cause extensive damage to the internal moving parts. Internal engine parts can also be affected by rust due to lack of proper lubrication

- Replace the engine oil and filter, running the engine to drain out as much old oil as possible.
- Flush the engine with fresh water using flush muffs or a similar device attached to the raw water pickup.
- Let all water drain from the engine.
- Fog the engine while it is running. Spray until it stalls.
- Run fuel which has been treated with conditioner and stabilizer through the engine.
- Replace lower unit gear oil. Check for moisture in old oil, a sign of deteriorating seals.
- Remove the prop and grease the shaft and threads.
- Treat all grease fittings with the recommended lubricant.
- Lightly lubricate the exterior of the engine or polish with a good wax.
- Check engine mount bolts. Ensure that they are torqued to 55 ft/lbs.

In addition, be sure to follow all recommendations in your engine manufacturers operation manual.

Section 5 • Care & Maintenance

Fuel System

Tank(s), hoses, and fuel pumps should be treated to help prevent the formation of varnish and gum.

Temperature extremes will cause condensation to accumulate in an empty or partially filled fuel tank leading to fuel contamination and/or premature wear of your system.

Fill the tank 95 percent full to allow for expansion, and add fuel stabilizer and conditioner, following the manufacturer's recommendations, to provide fuel stability and corrosion protection.

NOTICE

Pay particular attention to the information provided in "Ethanol-Blended Fuel" in section 3 of this manual.

Electrical System

- Check all connections and tighten if necessary.
- Spray all connections with an anti-corrosion spray.

Battery

NOTICE

Remove battery from boat and store in a cool, dry location. Periodically check the battery during storage.

NOTICE

Follow the manufacturer's recommendations for long term storage of your battery(s).

- Disconnect the battery cables (negative cable first).
- Remove the battery from the boat.
- Clean the terminal ends of the cables and battery terminals with a solution of baking soda and water. Rinse thoroughly with clean water.

- Apply a coat of grease on the terminal ends of the cables and the battery terminals.
- Store the battery in a cool, dry area.
- Use a trickle charger to keep the battery charged or charge the battery every 30-60 days.

Deck

Clean the deck with soap, hot water and a stiff brush to clean up any oil spills.

Drainage

It is important to raise the bow of the boat enough to allow for proper drainage of water from the deck and bilge area. Make sure all the drainage fittings are clear and free of debris and plugs are removed. Store the engine in an upright position to promote adequate drainage of water.

Avoid Loss

Remove any valuables or anything that can be easily removed from the boat such as electronics, lines, PFDs, fenders, cushions, etc. and store at home.

Cover

When covering your boat it is best to use a frame of either aluminum or wood to keep the cover up. This allows air to circulate and discourages water from pooling on the cover.

NOTICE

DO NOT USE a bimini top in lieu of a cover. Damage and aging will occur while providing no protection for your boat.

Vents along the entire length of the cover will allow condensation to escape. Placing a series of foam pads between the hull and cover will also aid in air circulation and reduce condensation.

To help keep your boat dry and mildew free, consider placing commercial odor and moisture absorbing products in the boat under the cover.

Section 5 • Care & Maintenance

Trailer Storage

Repeatedly immersing the trailer in water during boat launching can cause a variety of problems. Water seeping into the wheel hubs will cause the grease to emulsify and can prematurely corrode the bearings.

Check with the trailer manufacturer for scheduled maintenance of your trailer.

Environment

Antifreeze and other winterizing fluids can be toxic to aquatic life and cause harmful effects to plant life.

Improper disposal of, or spillage of antifreeze and/or any winterization fluids can cause environmental problems when allowed to empty into waterways or on the ground. Furthermore, it is illegal, punishable at minimum by fines.

Used antifreeze or any winterization fluids, should not be disposed of into sanitary sewers or publicly owned treatment plants.

Persons who have any questions regarding recycling antifreeze or other toxic fluids should write or call their state's EPA office.

Reinforcement Locations

Your boat has been manufactured with reinforcement in various locations throughout the deck.

In the event you wish to add equipment to your boat which requires you to penetrate the deck with fasteners, the diagram on page 5-11 illustrates the size, location and type of the reinforcement available. The chart below provides a description of the material and recommended fasteners to secure your equipment.

CAUTION

Do not attempt to secure equipment in any location other than those that are illustrated.

| Reinforcement | Construction | Equipment weight | Fastener Type* |
|---------------|---------------------------------------|------------------|---------------------|
| Plywood | Standard boatbuilding material | Light | Self-tapping screws |
| Trevira | Thick spunbound polyester fabric | Light | Sheet Metal screws |
| Sparalloy | High density plastic | Medium | Self-tapping screws |
| Phenolic** | Fiberglass reinforced composite board | Heavy | Drill & Tap |

* In all cases it is recommended to drill and countersink a pilot hole to prevent damage to the gelcoat surface.
** Also known as Whaleboard

Section 5 • Care & Maintenance

Reinforcement Location Diagram

